

LINE

1 BEDROOM — SUITE 1A

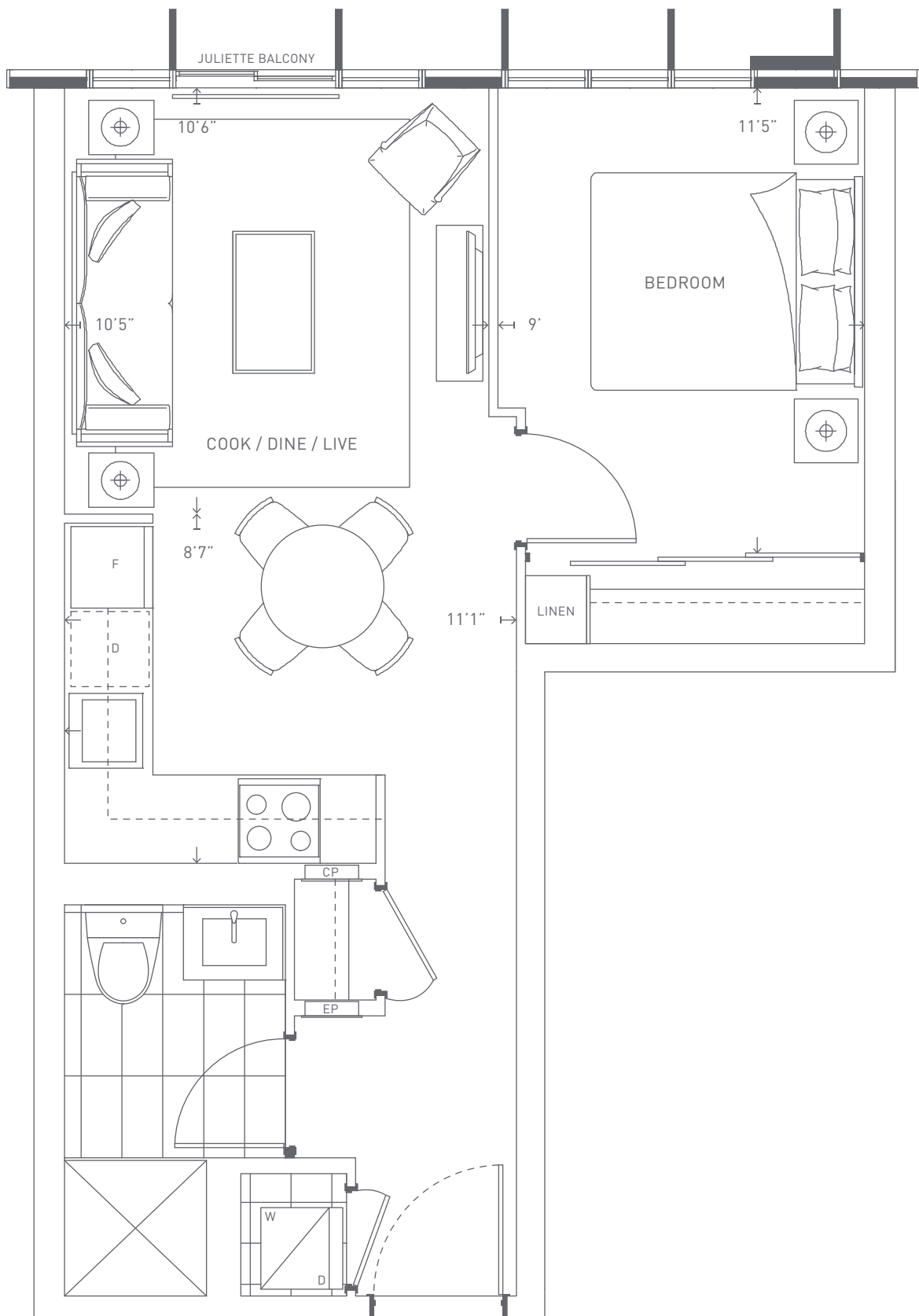

©Tridel 2016. ®Tridel and design, "D" design, Tridel Built for Life and design, Built Green. Built for Life and design are registered Trademarks of Tridel Corporation. Project names and logos are Trademarks of their respective owners. All rights reserved. Illustrations are artist's concept only. All dimensions are approximate and subject to normal construction variances. Dimensions may exceed the useable floor area. Size and specifications subject to change without notice. Furniture is displayed for illustration purposes only and does not necessarily reflect the electrical plan for the suite. Suites are sold unfurnished. E.&O.E. March 2016. Suites will feature an in-floor perimeter hydronic heating with separate variable refrigerant flow cooling system which have in-floor ventilation in front of some windows. Suites will also feature an individual energy recovery ventilator (ERV) providing fresh air and heat recovery. Keyplan and window configurations displayed depicts a typical floor for the entire building. Actual floor may differ, please enquire with sales representative for more details.

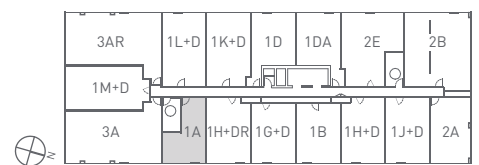

LINE

1 BEDROOM — SUITE 1B

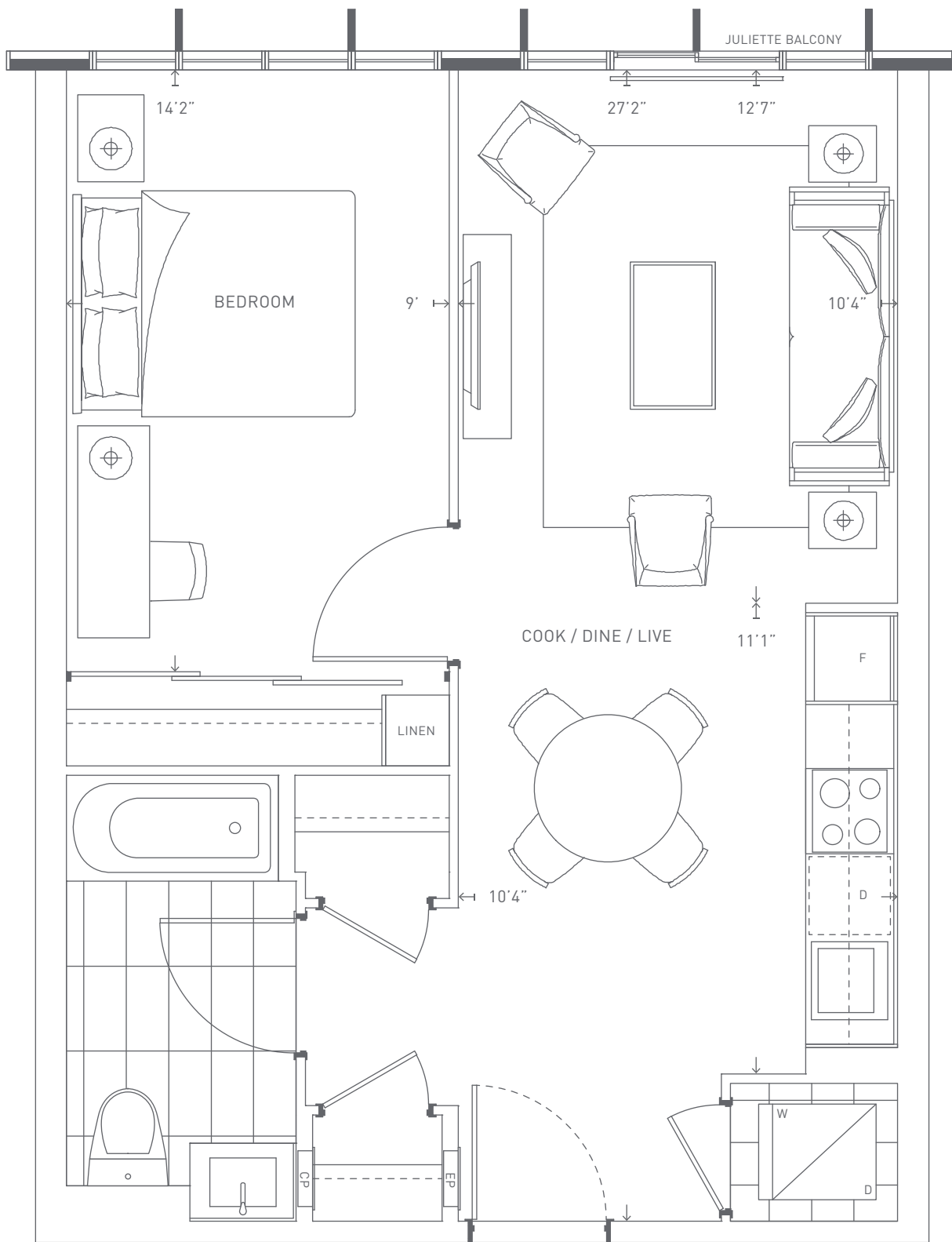

©Tridel 2016. ®Tridel and design, "D" design, Tridel Built for Life and design, Built Green. Built for Life and design are registered Trademarks of Tridel Corporation. Project names and logos are Trademarks of their respective owners. All rights reserved. Illustrations are artist's concept only. All dimensions are approximate and subject to normal construction variances. Dimensions may exceed the useable floor area. Size and specifications subject to change without notice. Furniture is displayed for illustration purposes only and does not necessarily reflect the electrical plan for the suite. Suites are sold unfurnished. E.&O.E. March 2016. Suites will feature an in-floor perimeter hydronic heating with separate variable refrigerant flow cooling system which have in-floor ventilation in front of some windows. Suites will also feature an individual energy recovery ventilator (ERV) providing fresh air and heat recovery. Keyplan and window configurations displayed depicts a typical floor for the entire building. Actual floor may differ, please enquire with sales representative for more details.

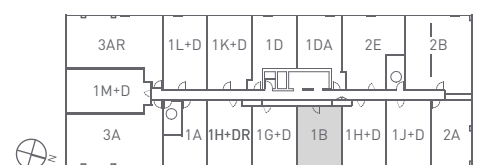

LINE

1 BEDROOM — SUITE 1C

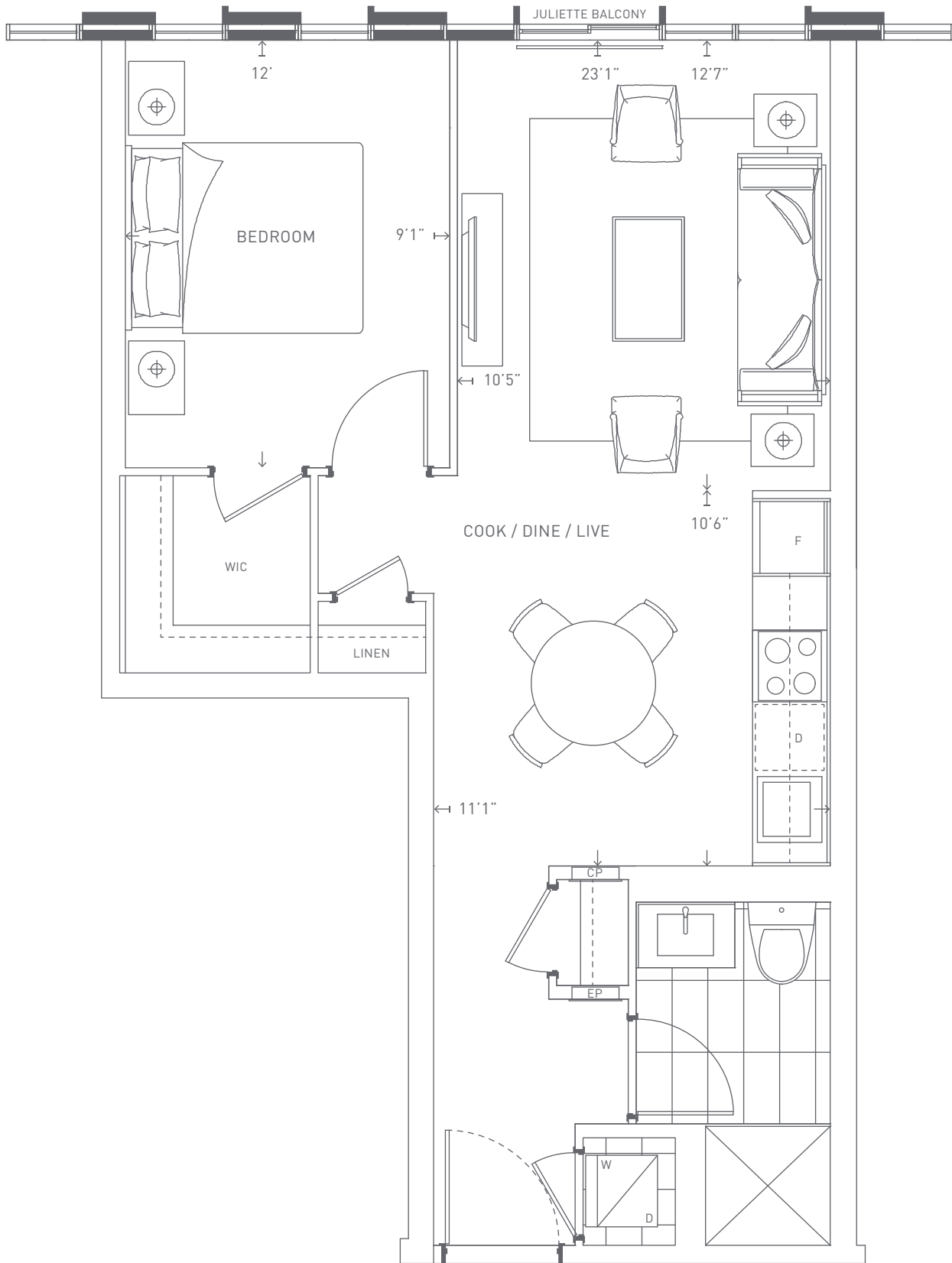

©Tridel 2016. ®Tridel and design, "D" design, Tridel Built for Life and design, Built Green. Built for Life and design are registered Trademarks of Tridel Corporation. Project names and logos are Trademarks of their respective owners. All rights reserved. Illustrations are artist's concept only. All dimensions are approximate and subject to normal construction variances. Dimensions may exceed the useable floor area. Size and specifications subject to change without notice. Furniture is displayed for illustration purposes only and does not necessarily reflect the electrical plan for the suite. Suites are sold unfurnished. E.&O.E. March 2016. Suites will feature an in-floor perimeter hydronic heating with separate variable refrigerant flow cooling system which have in-floor ventilation in front of some windows. Suites will also feature an individual energy recovery ventilator (ERV) providing fresh air and heat recovery. Keyplan and window configurations displayed depicts a typical floor for the entire building. Actual floor may differ, please enquire with sales representative for more details.

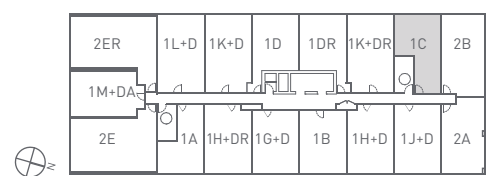

LINE

1 BEDROOM — SUITE 1D

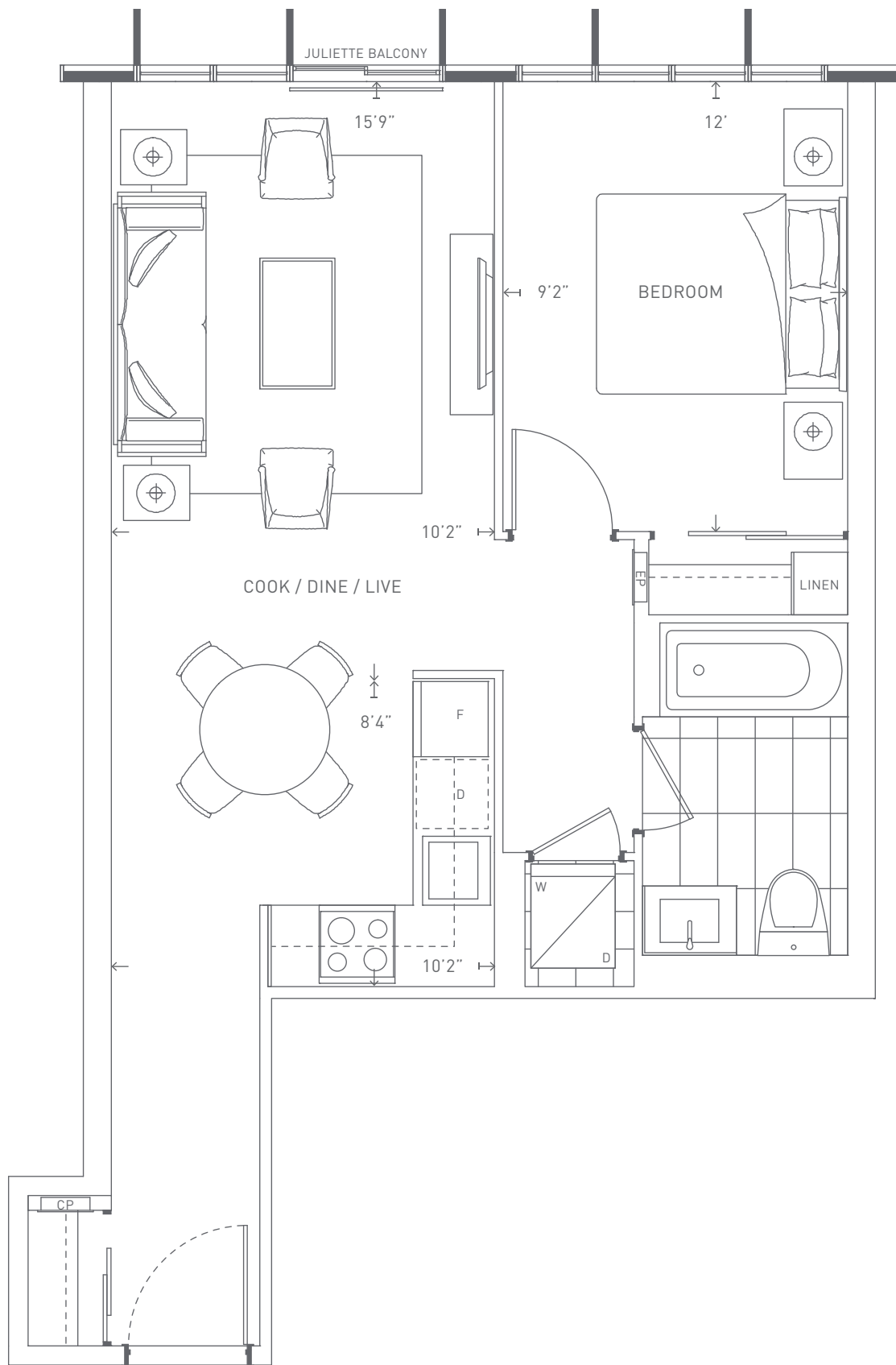

©Tridel 2016. ®Tridel and design, "D" design, Tridel Built for Life and design, Built Green. Built for Life and design are registered Trademarks of Tridel Corporation. Project names and logos are Trademarks of their respective owners. All rights reserved. Illustrations are artist's concept only. All dimensions are approximate and subject to normal construction variances. Dimensions may exceed the useable floor area. Size and specifications subject to change without notice. Furniture is displayed for illustration purposes only and does not necessarily reflect the electrical plan for the suite. Suites are sold unfurnished. E.&O.E. March 2016. Suites will feature an in-floor perimeter hydronic heating with separate variable refrigerant flow cooling system which have in-floor ventilation in front of some windows. Suites will also feature an individual energy recovery ventilator (ERV) providing fresh air and heat recovery. Keyplan and window configurations displayed depicts a typical floor for the entire building. Actual floor may differ, please enquire with sales representative for more details.

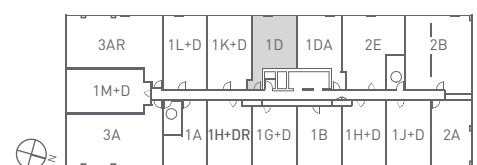

LINE

1 BEDROOM — SUITE 1DA

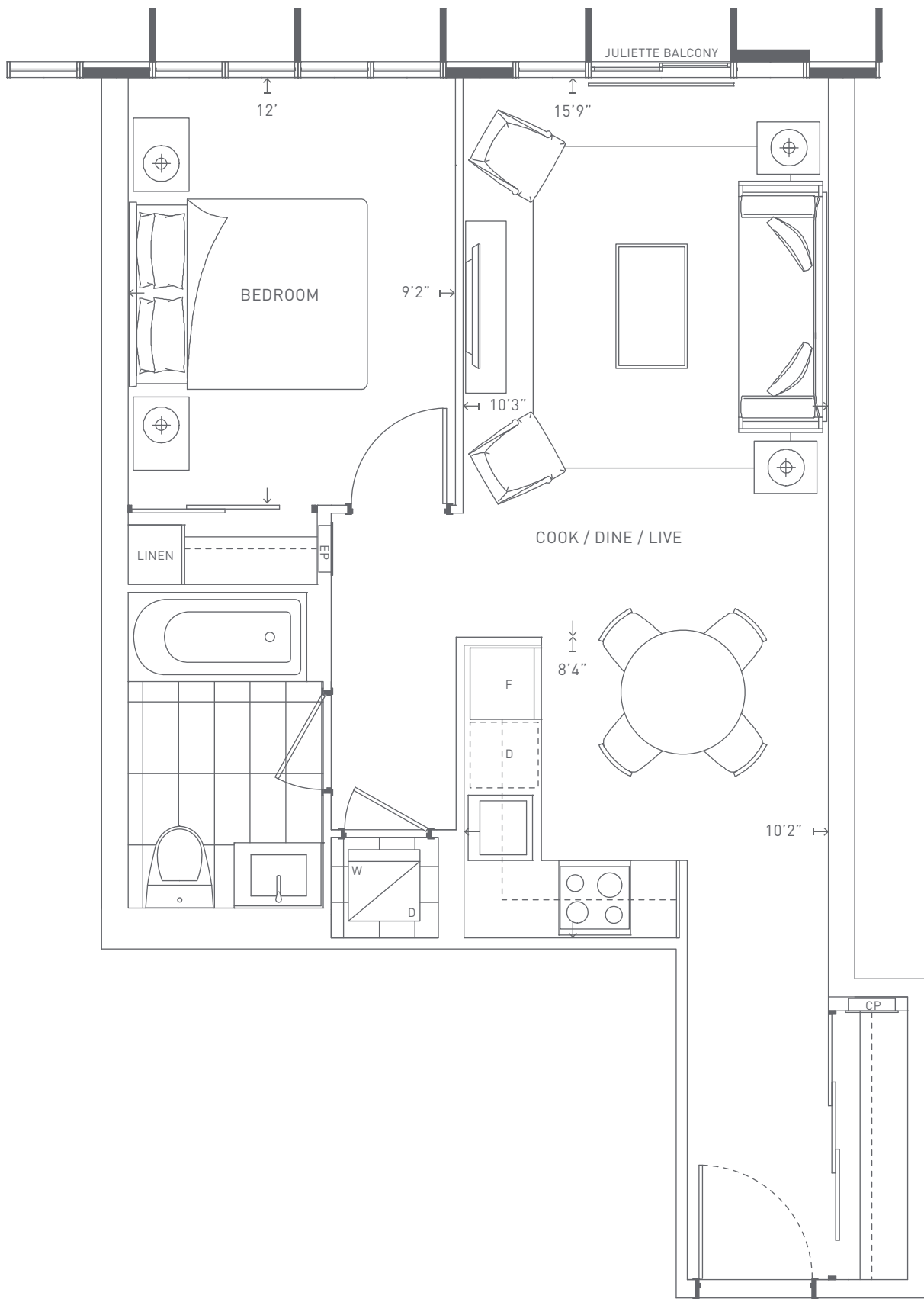

©Tridel 2016. ®Tridel and design, "D" design, Tridel Built for Life and design, Built Green. Built for Life and design are registered Trademarks of Tridel Corporation. Project names and logos are Trademarks of their respective owners. All rights reserved. Illustrations are artist's concept only. All dimensions are approximate and subject to normal construction variances. Dimensions may exceed the useable floor area. Size and specifications subject to change without notice. Furniture is displayed for illustration purposes only and does not necessarily reflect the electrical plan for the suite. Suites are sold unfurnished. E.&O.E. March 2016. Suites will feature an in-floor perimeter hydronic heating with separate variable refrigerant flow cooling system which have in-floor ventilation in front of some windows. Suites will also feature an individual energy recovery ventilator (ERV) providing fresh air and heat recovery. Keyplan and window configurations displayed depicts a typical floor for the entire building. Actual floor may differ, please enquire with sales representative for more details.

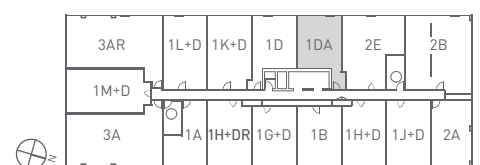

TEXTURE

I BEDROOM + DEN — SUITE 1G+D

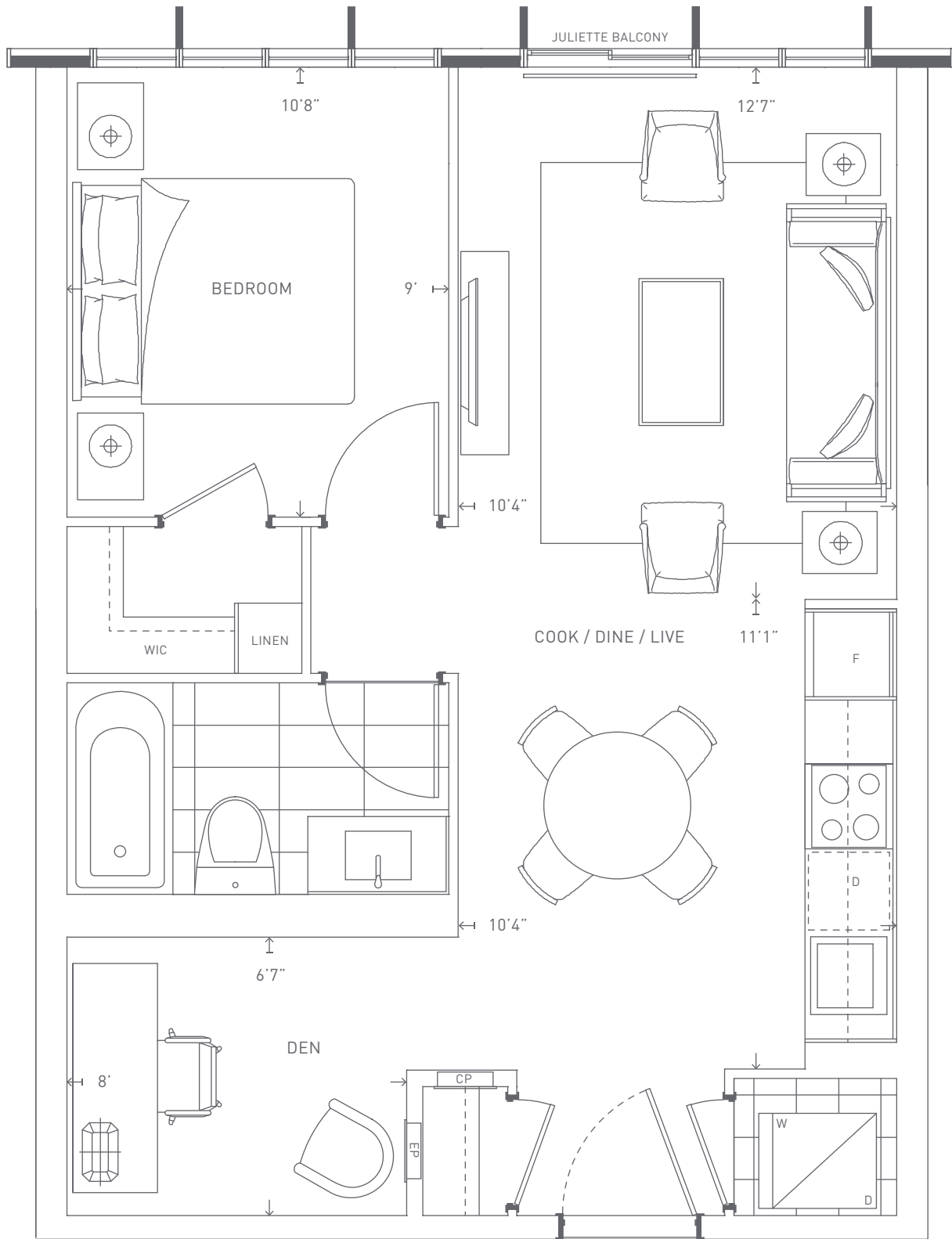

©Tridel 2016. ®Tridel and design, "D" design, Tridel Built for Life and design, Built Green. Built for Life and design are registered Trademarks of Tridel Corporation. Project names and logos are Trademarks of their respective owners. All rights reserved. Illustrations are artist's concept only. All dimensions are approximate and subject to normal construction variances. Dimensions may exceed the useable floor area. Size and specifications subject to change without notice. Furniture is displayed for illustration purposes only and does not necessarily reflect the electrical plan for the suite. Suites are sold unfurnished. E.&O.E. March 2016. Suites will feature an in-floor perimeter hydronic heating with separate variable refrigerant flow cooling system which have in-floor ventilation in front of some windows. Suites will also feature an individual energy recovery ventilator (ERV) providing fresh air and heat recovery. Keyplan and window configurations displayed depicts a typical floor for the entire building. Actual floor may differ, please enquire with sales representative for more details.

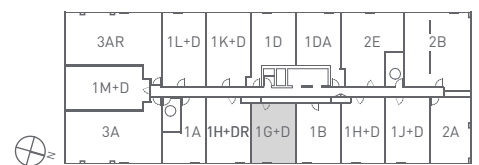

TEXTURE

I BEDROOM + DEN — SUITE 1H+D / 1H+DR

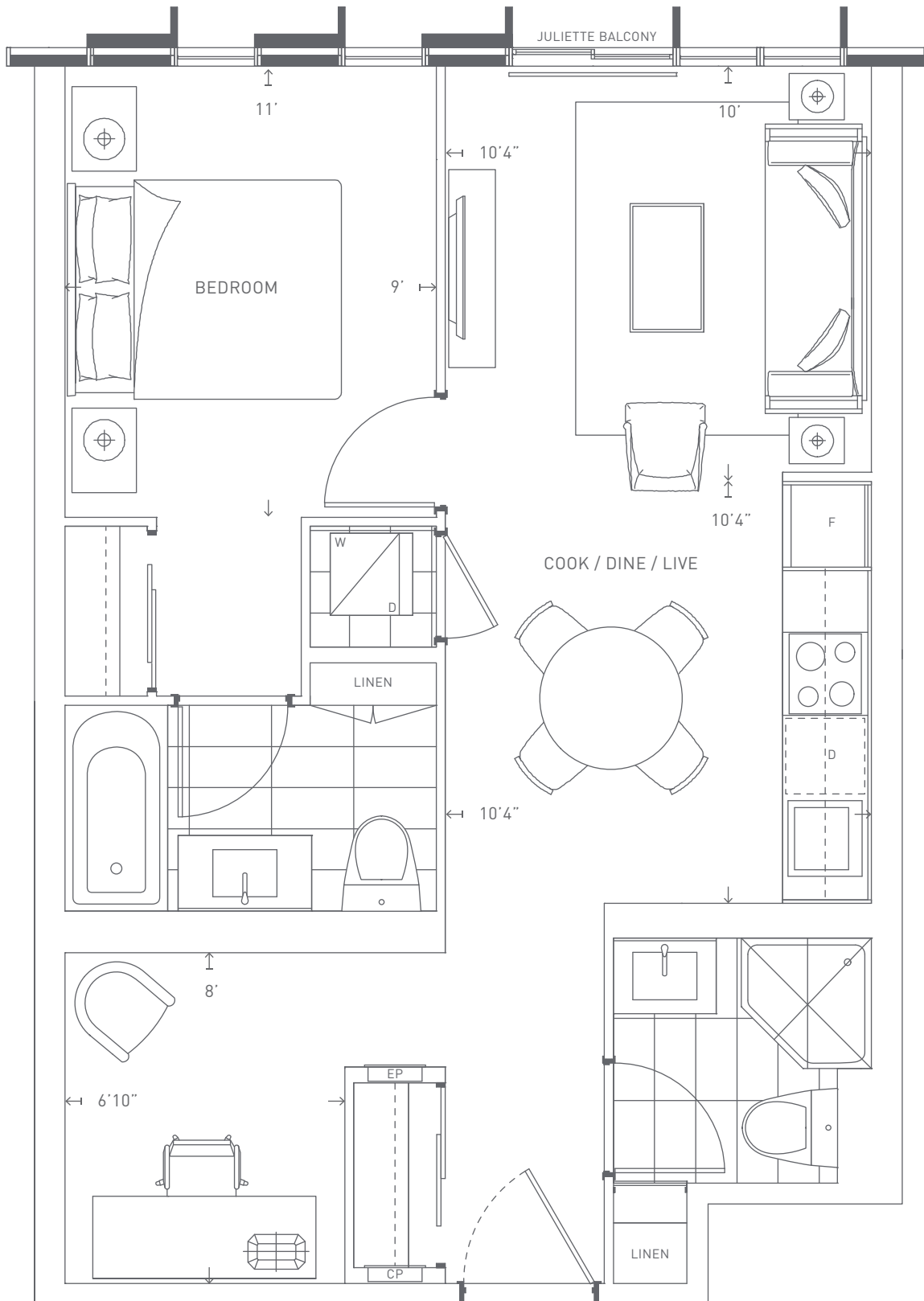

©Tridel 2016. ®Tridel and design, "D" design, Tridel Built for Life and design, Built Green. Built for Life and design are registered Trademarks of Tridel Corporation. Project names and logos are Trademarks of their respective owners. All rights reserved. Illustrations are artist's concept only. All dimensions are approximate and subject to normal construction variances. Dimensions may exceed the useable floor area. Size and specifications subject to change without notice. Furniture is displayed for illustration purposes only and does not necessarily reflect the electrical plan for the suite. Suites are sold unfurnished. E.&O.E. March 2016. Suites will feature an in-floor perimeter hydronic heating with separate variable refrigerant flow cooling system which have in-floor ventilation in front of some windows. Suites will also feature an individual energy recovery ventilator (ERV) providing fresh air and heat recovery. Keyplan and window configurations displayed depicts a typical floor for the entire building. Actual floor may differ, please enquire with sales representative for more details.

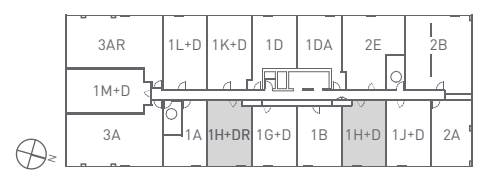

TEXTURE

I BEDROOM + DEN — SUITE 1J+D

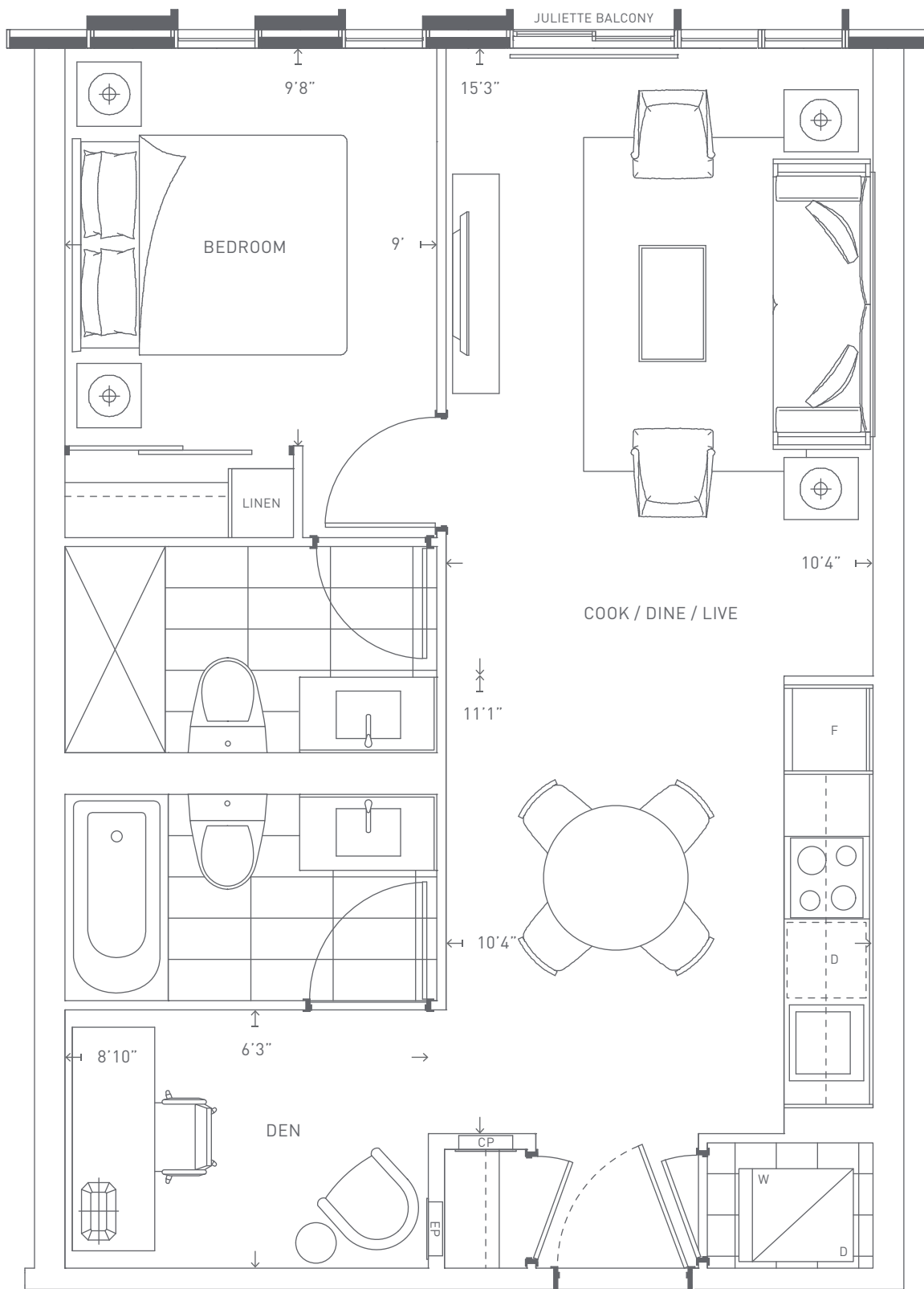

©Tridel 2016. ®Tridel and design, "D" design, Tridel Built for Life and design, Built Green. Built for Life and design are registered Trademarks of Tridel Corporation. Project names and logos are Trademarks of their respective owners. All rights reserved. Illustrations are artist's concept only. All dimensions are approximate and subject to normal construction variances. Dimensions may exceed the useable floor area. Size and specifications subject to change without notice. Furniture is displayed for illustration purposes only and does not necessarily reflect the electrical plan for the suite. Suites are sold unfurnished. E.&O.E. March 2016. Suites will feature an in-floor perimeter hydronic heating with separate variable refrigerant flow cooling system which have in-floor ventilation in front of some windows. Suites will also feature an individual energy recovery ventilator (ERV) providing fresh air and heat recovery. Keyplan and window configurations displayed depicts a typical floor for the entire building. Actual floor may differ, please enquire with sales representative for more details.

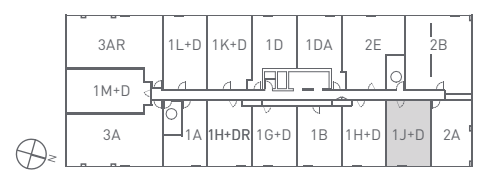

TEXTURE

I BEDROOM + DEN — SUITE 1K+D

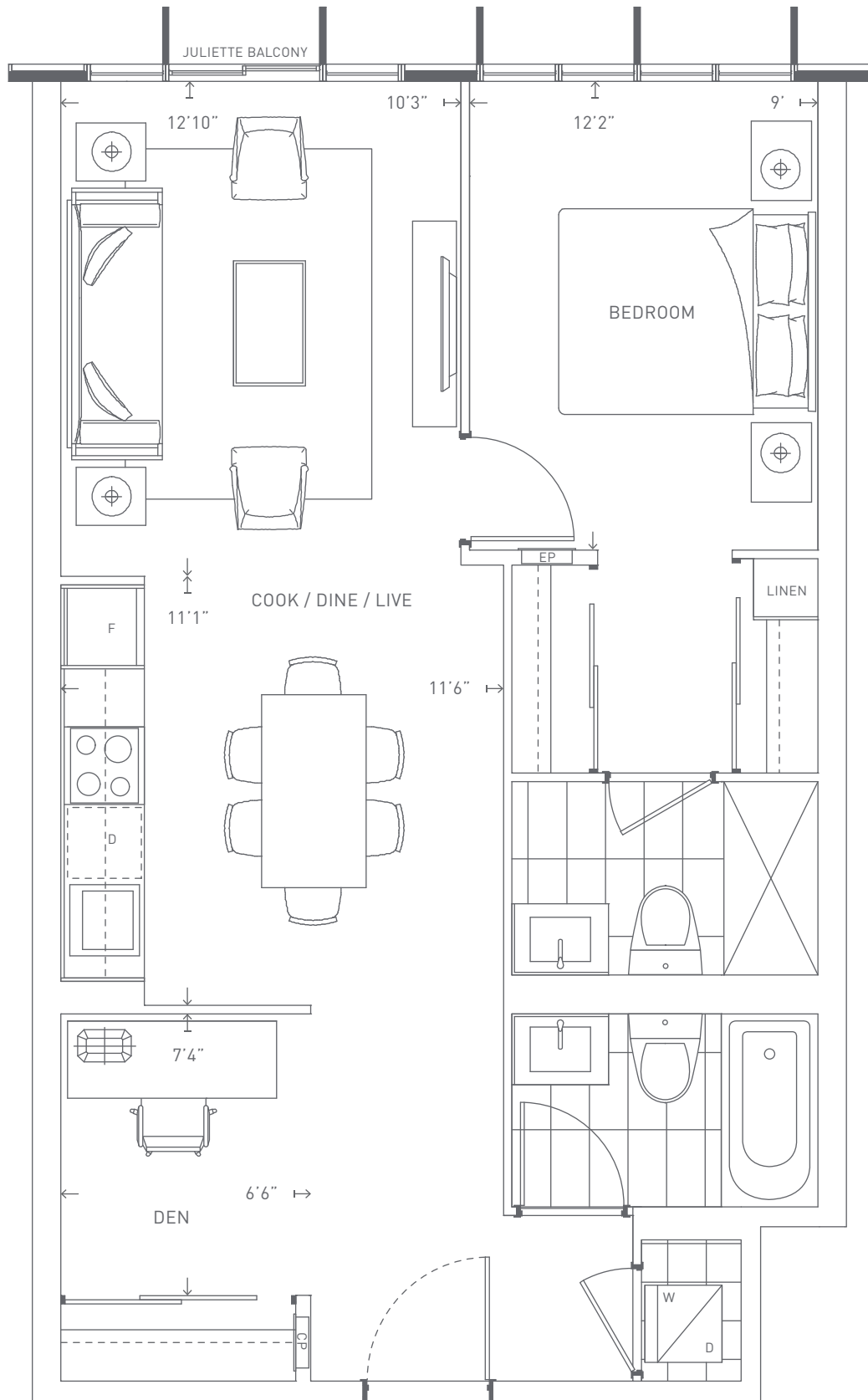

©Tridel 2016. ®Tridel and design, "D" design, Tridel Built for Life and design, Built Green. Built for Life and design are registered Trademarks of Tridel Corporation. Project names and logos are Trademarks of their respective owners. All rights reserved. Illustrations are artist's concept only. All dimensions are approximate and subject to normal construction variances. Dimensions may exceed the useable floor area. Size and specifications subject to change without notice. Furniture is displayed for illustration purposes only and does not necessarily reflect the electrical plan for the suite. Suites are sold unfurnished. E.&O.E. March 2016. Suites will feature an in-floor perimeter hydronic heating with separate variable refrigerant flow cooling system which have in-floor ventilation in front of some windows. Suites will also feature an individual energy recovery ventilator (ERV) providing fresh air and heat recovery. Keyplan and window configurations displayed depicts a typical floor for the entire building. Actual floor may differ, please enquire with sales representative for more details.

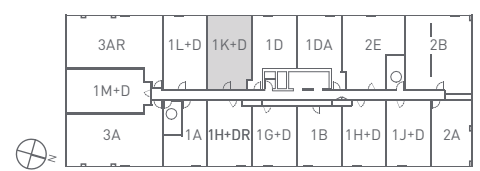

TEXTURE

I BEDROOM + DEN — SUITE 1L+D

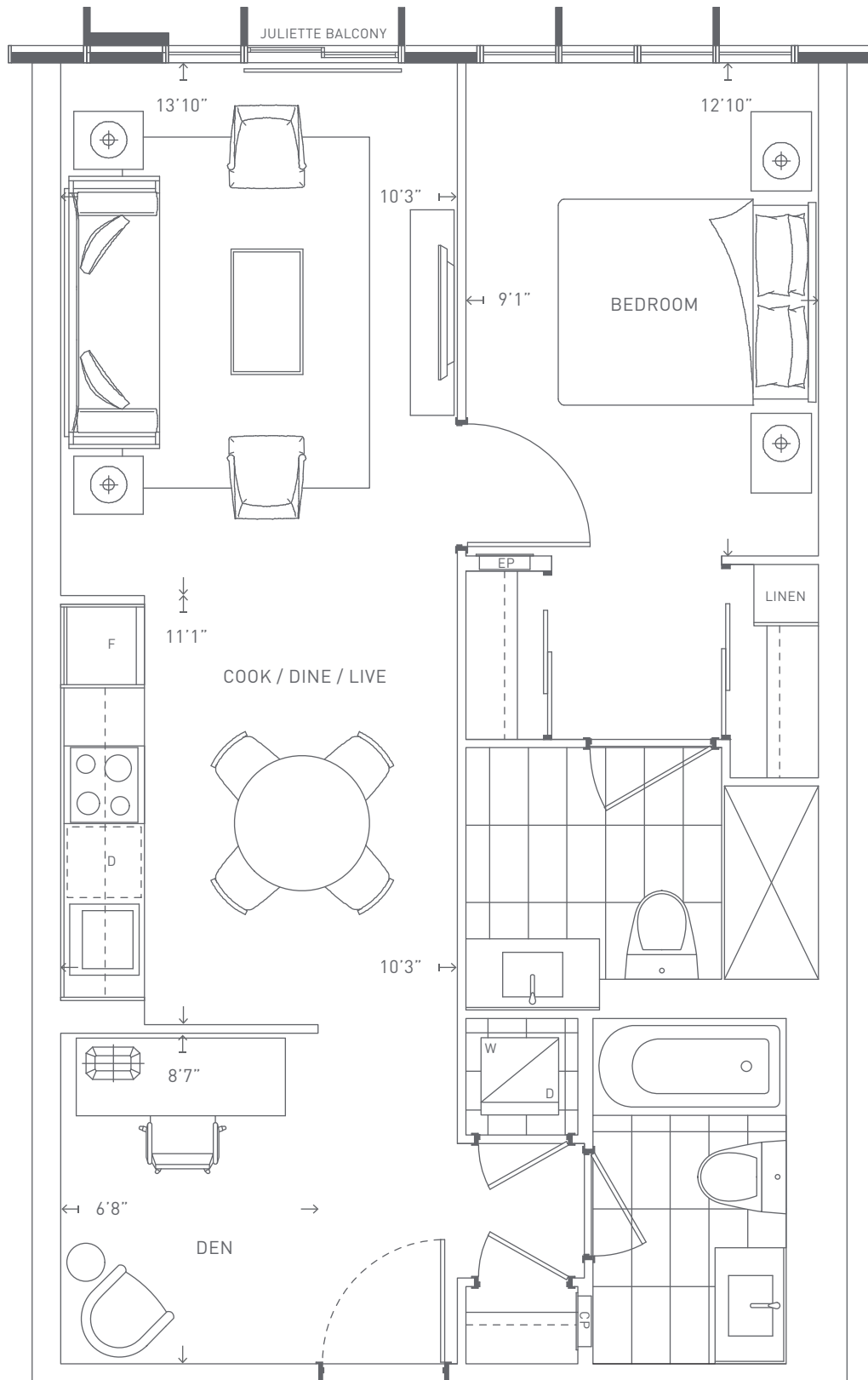

©Tridel 2016. ®Tridel and design, "D" design, Tridel Built for Life and design, Built Green. Built for Life and design are registered Trademarks of Tridel Corporation. Project names and logos are Trademarks of their respective owners. All rights reserved. Illustrations are artist's concept only. All dimensions are approximate and subject to normal construction variances. Dimensions may exceed the useable floor area. Size and specifications subject to change without notice. Furniture is displayed for illustration purposes only and does not necessarily reflect the electrical plan for the suite. Suites are sold unfurnished. E.&O.E. March 2016. Suites will feature an in-floor perimeter hydronic heating with separate variable refrigerant flow cooling system which have in-floor ventilation in front of some windows. Suites will also feature an individual energy recovery ventilator (ERV) providing fresh air and heat recovery. Keyplan and window configurations displayed depicts a typical floor for the entire building. Actual floor may differ, please enquire with sales representative for more details.

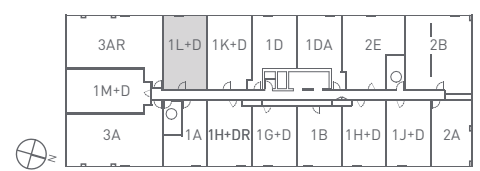

TEXTURE

I BEDROOM + DEN — SUITE 1M+D

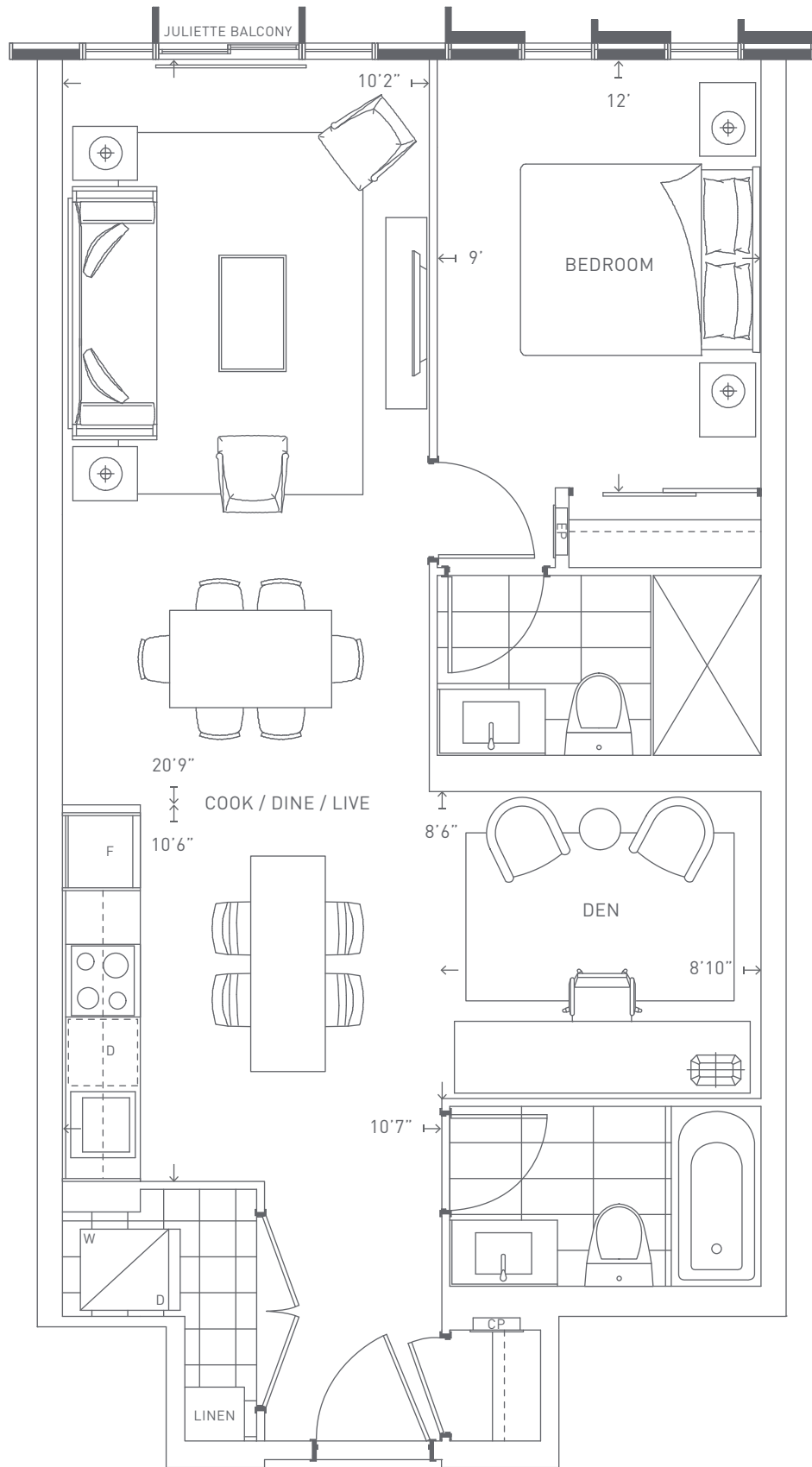

©Tridel 2016. ®Tridel and design, "D" design, Tridel Built for Life and design, Built Green. Built for Life and design are registered Trademarks of Tridel Corporation. Project names and logos are Trademarks of their respective owners. All rights reserved. Illustrations are artist's concept only. All dimensions are approximate and subject to normal construction variances. Dimensions may exceed the useable floor area. Size and specifications subject to change without notice. Furniture is displayed for illustration purposes only and does not necessarily reflect the electrical plan for the suite. Suites are sold unfurnished. E.&O.E. March 2016. Suites will feature an in-floor perimeter hydronic heating with separate variable refrigerant flow cooling system which have in-floor ventilation in front of some windows. Suites will also feature an individual energy recovery ventilator (ERV) providing fresh air and heat recovery. Keyplan and window configurations displayed depicts a typical floor for the entire building. Actual floor may differ, please enquire with sales representative for more details.

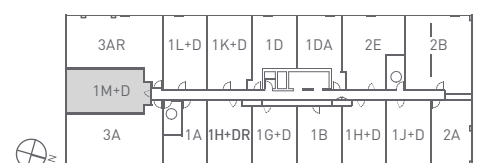

SHAPE

2 BEDROOM — SUITE 2A

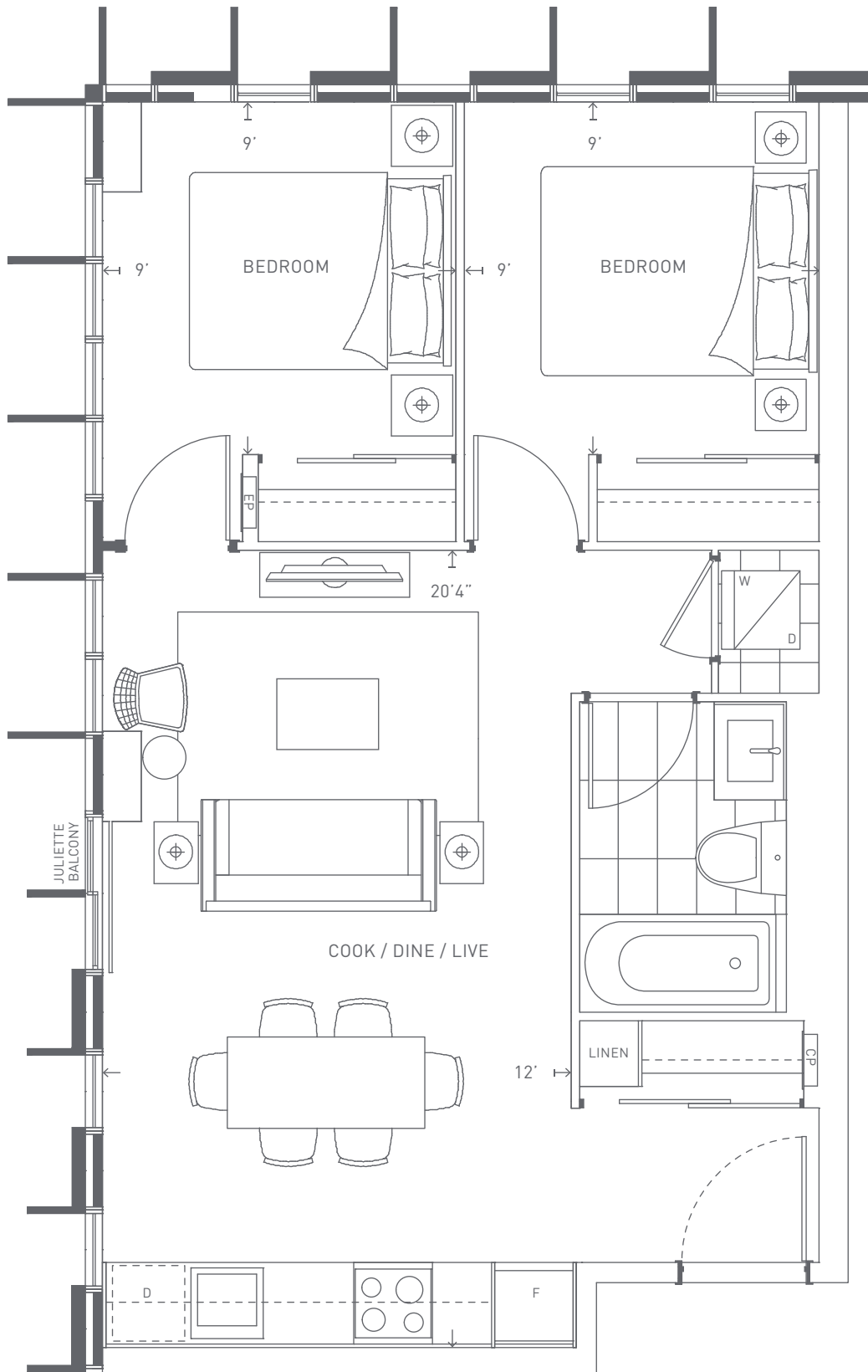

©Tridel 2016. ®Tridel and design, "D" design, Tridel Built for Life and design, Built Green. Built for Life and design are registered Trademarks of Tridel Corporation. Project names and logos are Trademarks of their respective owners. All rights reserved. Illustrations are artist's concept only. All dimensions are approximate and subject to normal construction variances. Dimensions may exceed the useable floor area. Size and specifications subject to change without notice. Furniture is displayed for illustration purposes only and does not necessarily reflect the electrical plan for the suite. Suites are sold unfurnished. E.&O.E. March 2016. Suites will feature an in-floor perimeter hydronic heating with separate variable refrigerant flow cooling system which have in-floor ventilation in front of some windows. Suites will also feature an individual energy recovery ventilator (ERV) providing fresh air and heat recovery. Keyplan and window configurations displayed depicts a typical floor for the entire building. Actual floor may differ, please enquire with sales representative for more details.

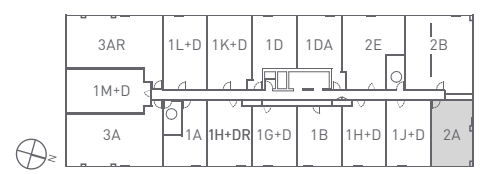

SHAPE

2 BEDROOM — SUITE 2B

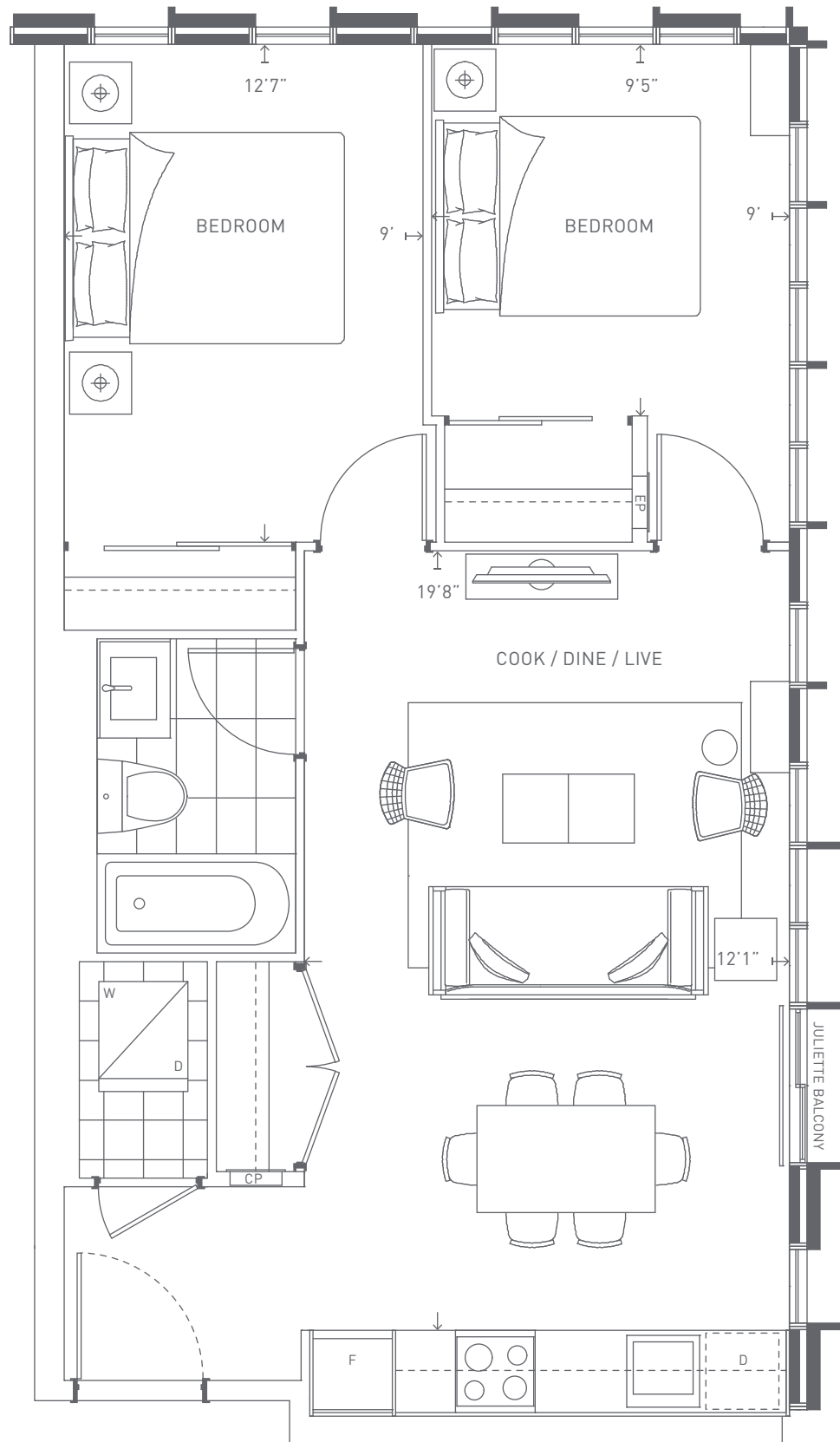

©Tridel 2016. ®Tridel and design, "D" design, Tridel Built for Life and design, Built Green. Built for Life and design are registered Trademarks of Tridel Corporation. Project names and logos are Trademarks of their respective owners. All rights reserved. Illustrations are artist's concept only. All dimensions are approximate and subject to normal construction variances. Dimensions may exceed the useable floor area. Size and specifications subject to change without notice. Furniture is displayed for illustration purposes only and does not necessarily reflect the electrical plan for the suite. Suites are sold unfurnished. E.&O.E. March 2016. Suites will feature an in-floor perimeter hydronic heating with separate variable refrigerant flow cooling system which have in-floor ventilation in front of some windows. Suites will also feature an individual energy recovery ventilator (ERV) providing fresh air and heat recovery. Keyplan and window configurations displayed depicts a typical floor for the entire building. Actual floor may differ, please enquire with sales representative for more details.

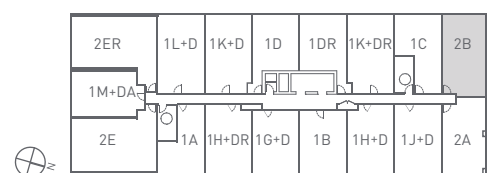

SHAPE

2 BEDROOM — SUITE 2E

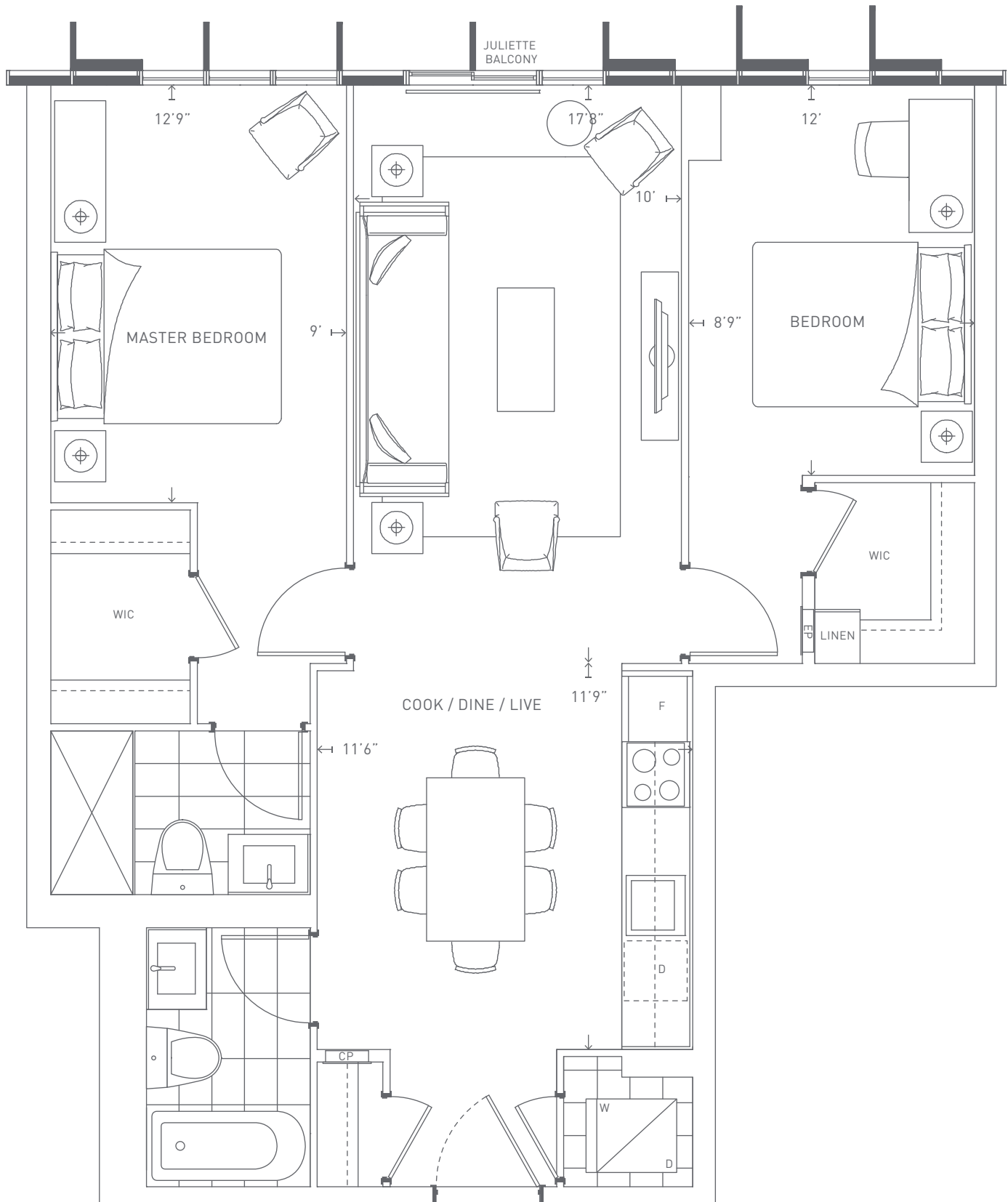

©Tridel 2016. ®Tridel and design, "D" design, Tridel Built for Life and design, Built Green. Built for Life and design are registered Trademarks of Tridel Corporation. Project names and logos are Trademarks of their respective owners. All rights reserved. Illustrations are artist's concept only. All dimensions are approximate and subject to normal construction variances. Dimensions may exceed the useable floor area. Size and specifications subject to change without notice. Furniture is displayed for illustration purposes only and does not necessarily reflect the electrical plan for the suite. Suites are sold unfurnished. E.&O.E. March 2016. Suites will feature an in-floor perimeter hydronic heating with separate variable refrigerant flow cooling system which have in-floor ventilation in front of some windows. Suites will also feature an individual energy recovery ventilator (ERV) providing fresh air and heat recovery. Keyplan and window configurations displayed depicts a typical floor for the entire building. Actual floor may differ, please enquire with sales representative for more details.

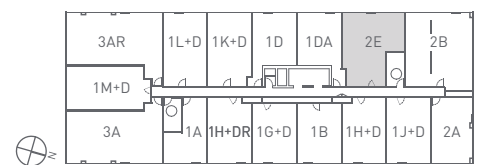

SPACE

3 BEDROOM — SUITE 3A/3AR

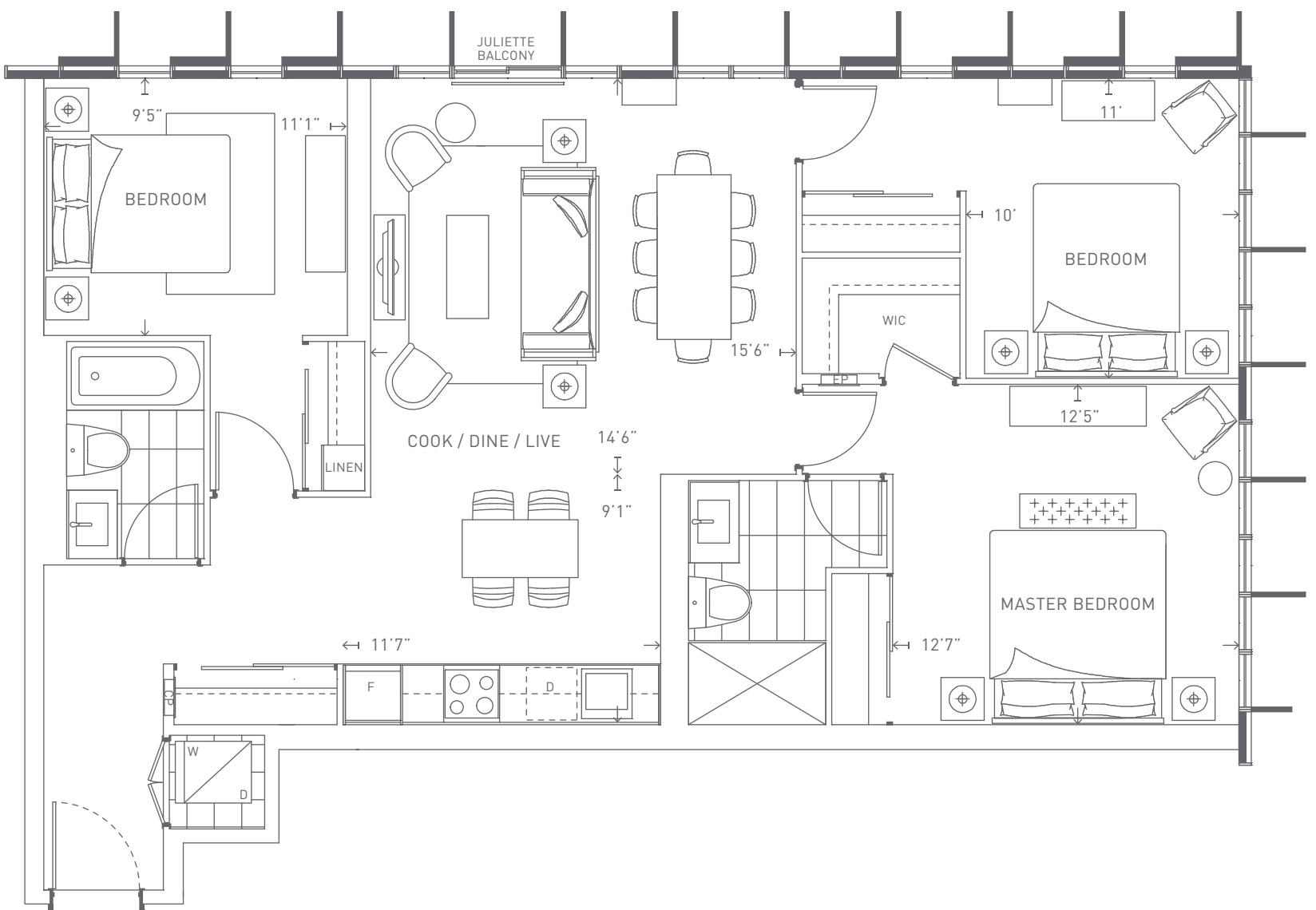

©Tridel 2016. ®Tridel and design, "D" design, Tridel Built for Life and design, Built Green. Built for Life and design are registered Trademarks of Tridel Corporation. Project names and logos are Trademarks of their respective owners. All rights reserved. Illustrations are artist's concept only. All dimensions are approximate and subject to normal construction variances. Dimensions may exceed the useable floor area. Size and specifications subject to change without notice. Furniture is displayed for illustration purposes only and does not necessarily reflect the electrical plan for the suite. Suites are sold unfurnished. E.&O.E. March 2016. Suites will feature an in-floor perimeter hydronic heating with separate variable refrigerant flow cooling system which have in-floor ventilation in front of some windows. Suites will also feature an individual energy recovery ventilator (ERV) providing fresh air and heat recovery. Keyplan and window configurations displayed depicts a typical floor for the entire building. Actual floor may differ, please enquire with sales representative for more details.

