

SUITE 1-A

THE MET

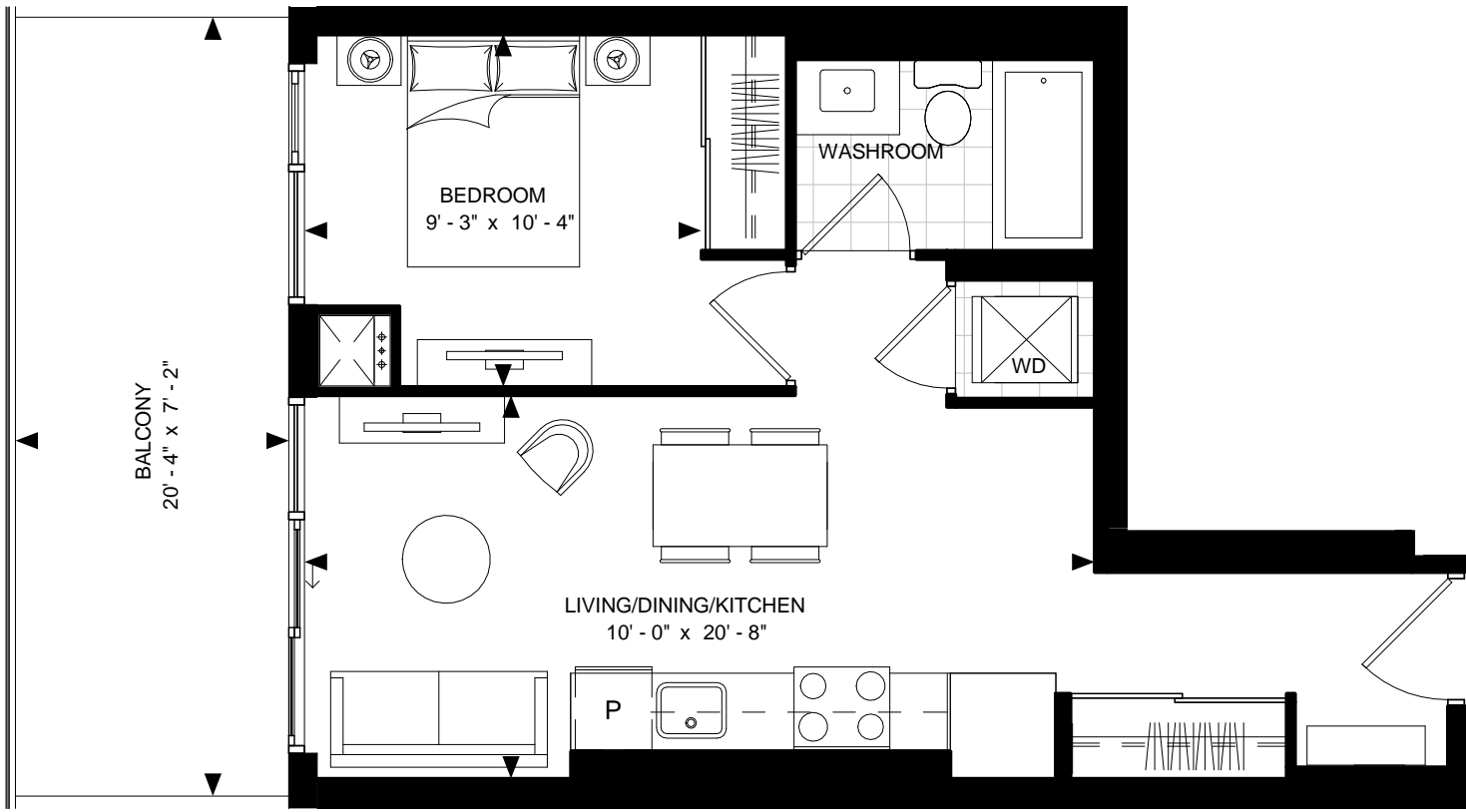

BALCONY AT SUITES 309, 310, 509-909, 510-910

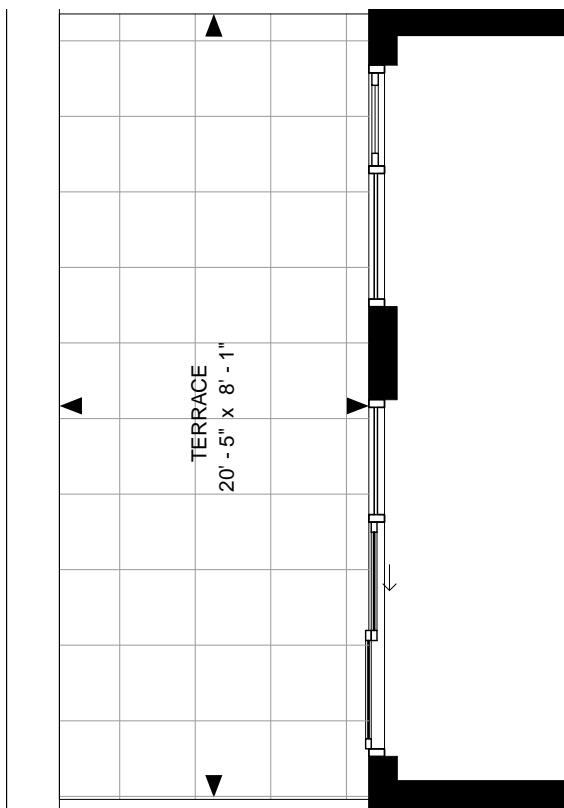

TERRACE AT SUITES 209, 210, 1010

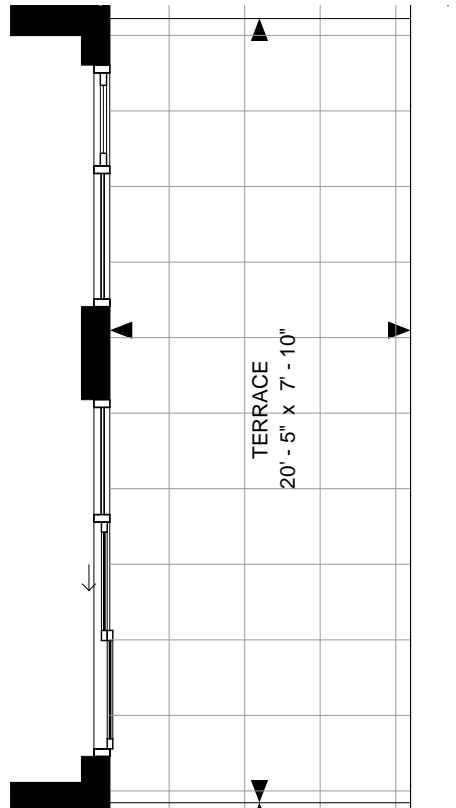

TERRACE AT SUITES 201 & 218

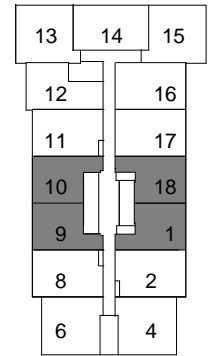

FLOOR 11-12, 15-36, LPH & PH

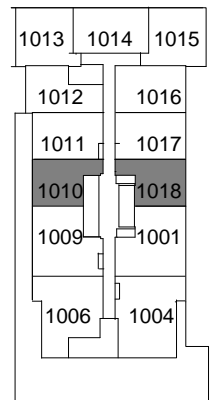

FLOOR 10

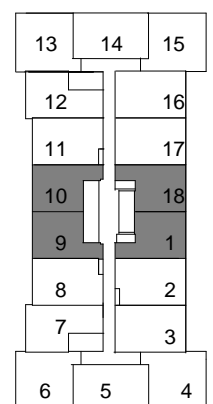

FLOOR 2-3, 5-9

BALCONY AT SUITES
301, 318, 501-901, 1101, 1201,
518-1218, 1109-1209, 1110-
1210, 1509-1909, 1510-3610,
1501-3601, LPH01, PH01,
LPH10, PH10

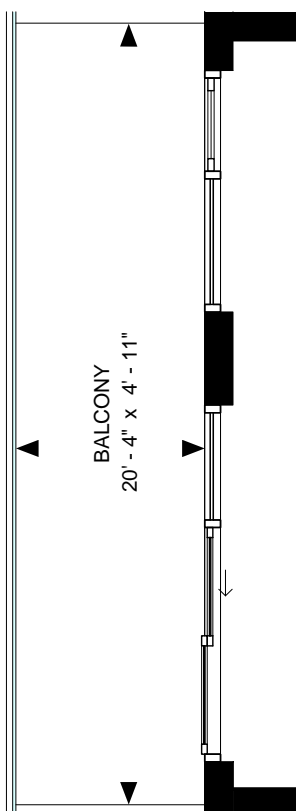

SUITE 1-A
SUITE AREA: 510 sf

BALCONY AT SUITES
1518-3618, 2009-3609,
LPH18, PH18, LPH09, PH09

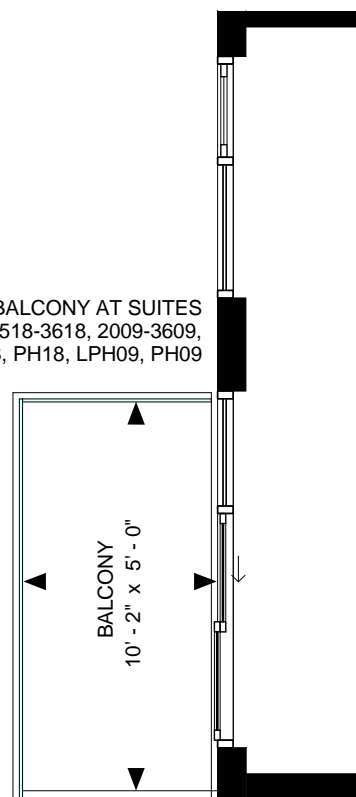

Disclaimer : Materials, specifications & floor plans are subject to change without notice. All renderings are artist's conceptions. All floor plans have approximate dimensions. Actual usable floor space may vary from the stated floor area. E.&O.E.

NOT TO SCALE

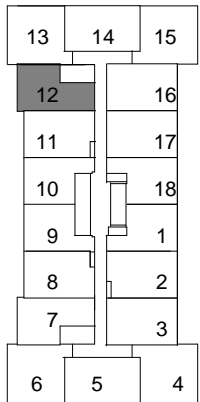
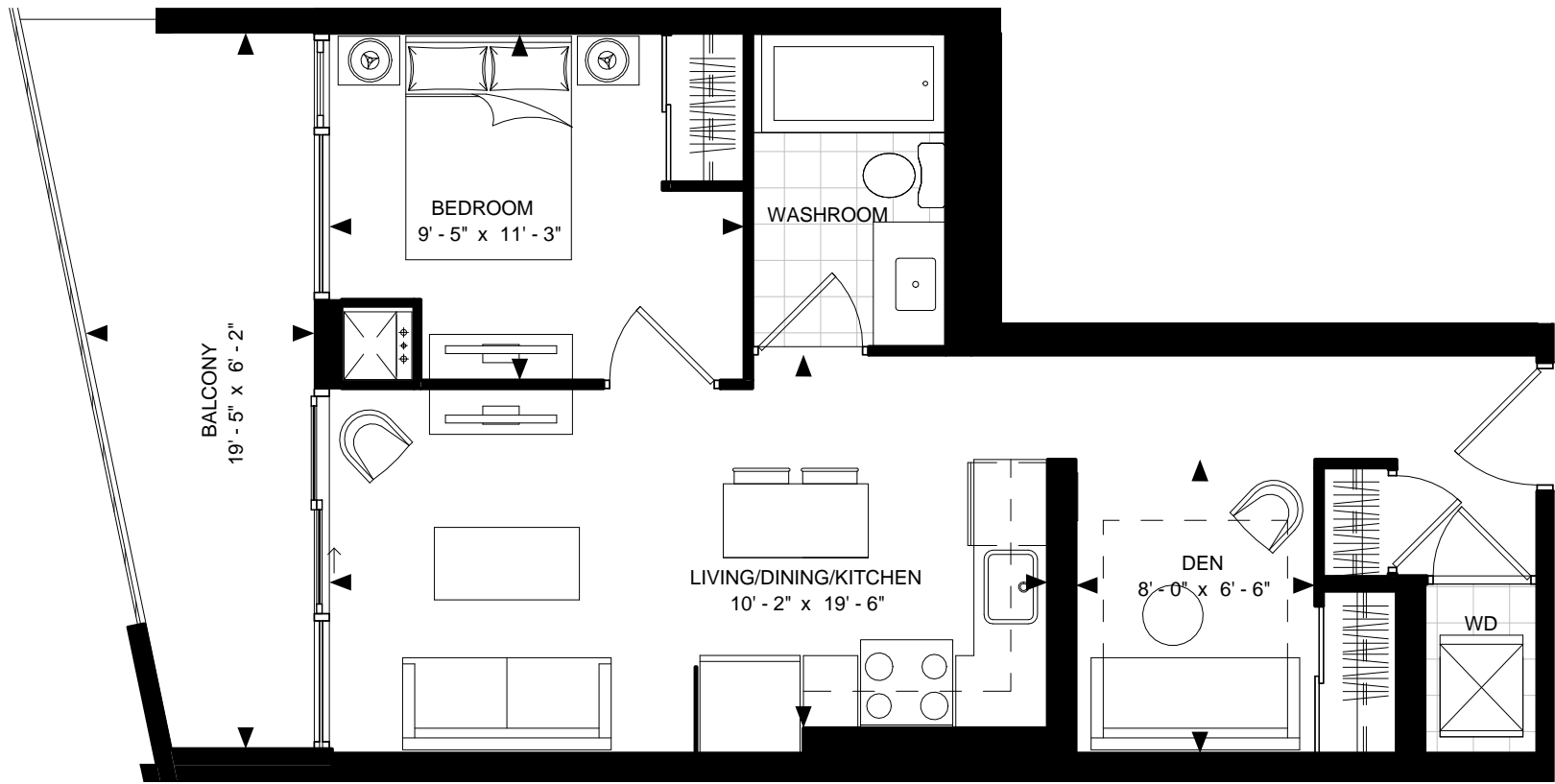

FLOOR 2-3, 5-9

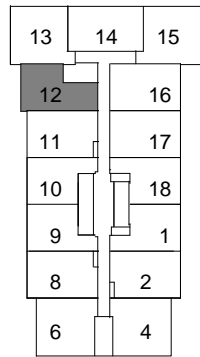

FLOOR 10-12, 15-36, LPH & PH

SUITE 1D1-A
SUITE AREA: 562 sf



Disclaimer : Materials, specifications & floor plans are subject to change without notice. All renderings are artist's conceptions. All floor plans have approximate dimensions. Actual usable floor space may vary from the stated floor area. E.&O.E.

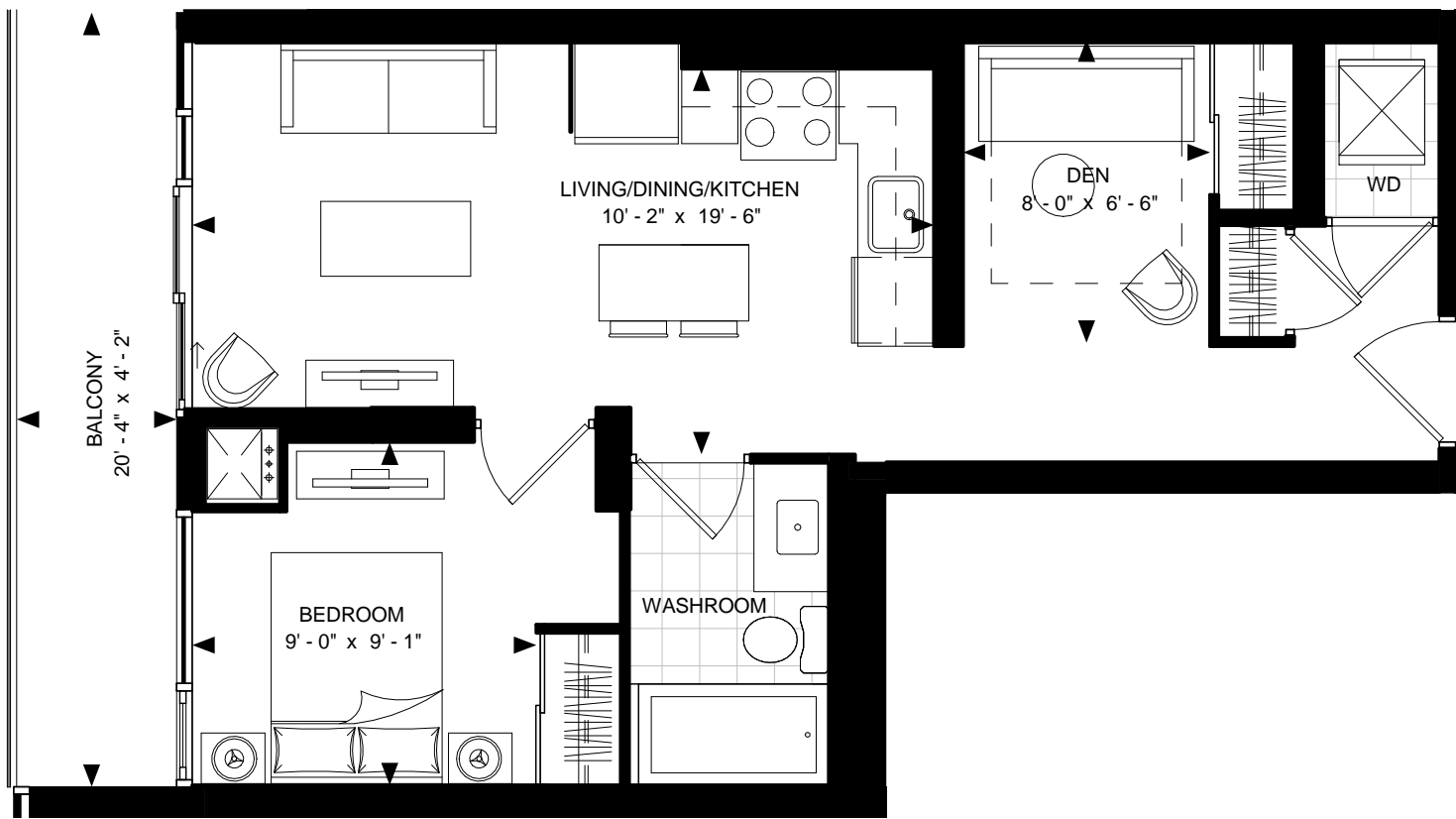

BALCONY AT SUITES 307, 507-907

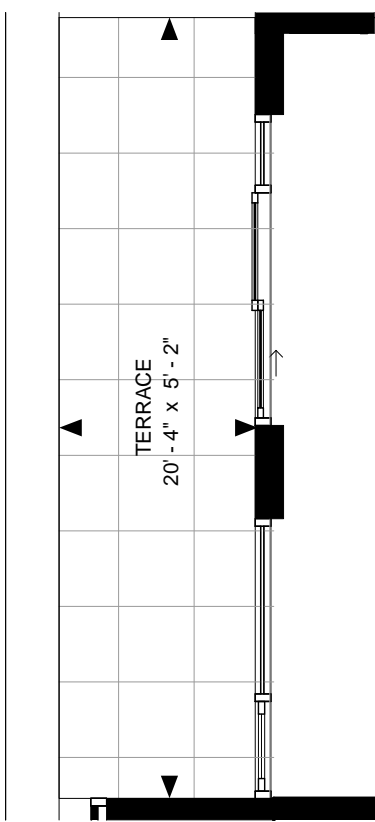

TERRACE AT SUITE 207

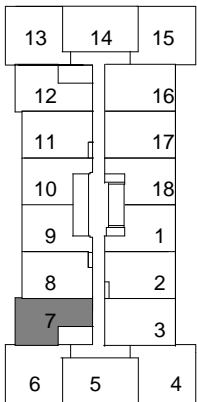

FLOOR 2-3, 5-9

SUITE 1D1-A1
SUITE AREA: 562 sf



Disclaimer : Materials, specifications & floor plans are subject to change without notice. All renderings are artist's conceptions. All floor plans have approximate dimensions. Actual usable floor space may vary from the stated floor area. E.&O.E.

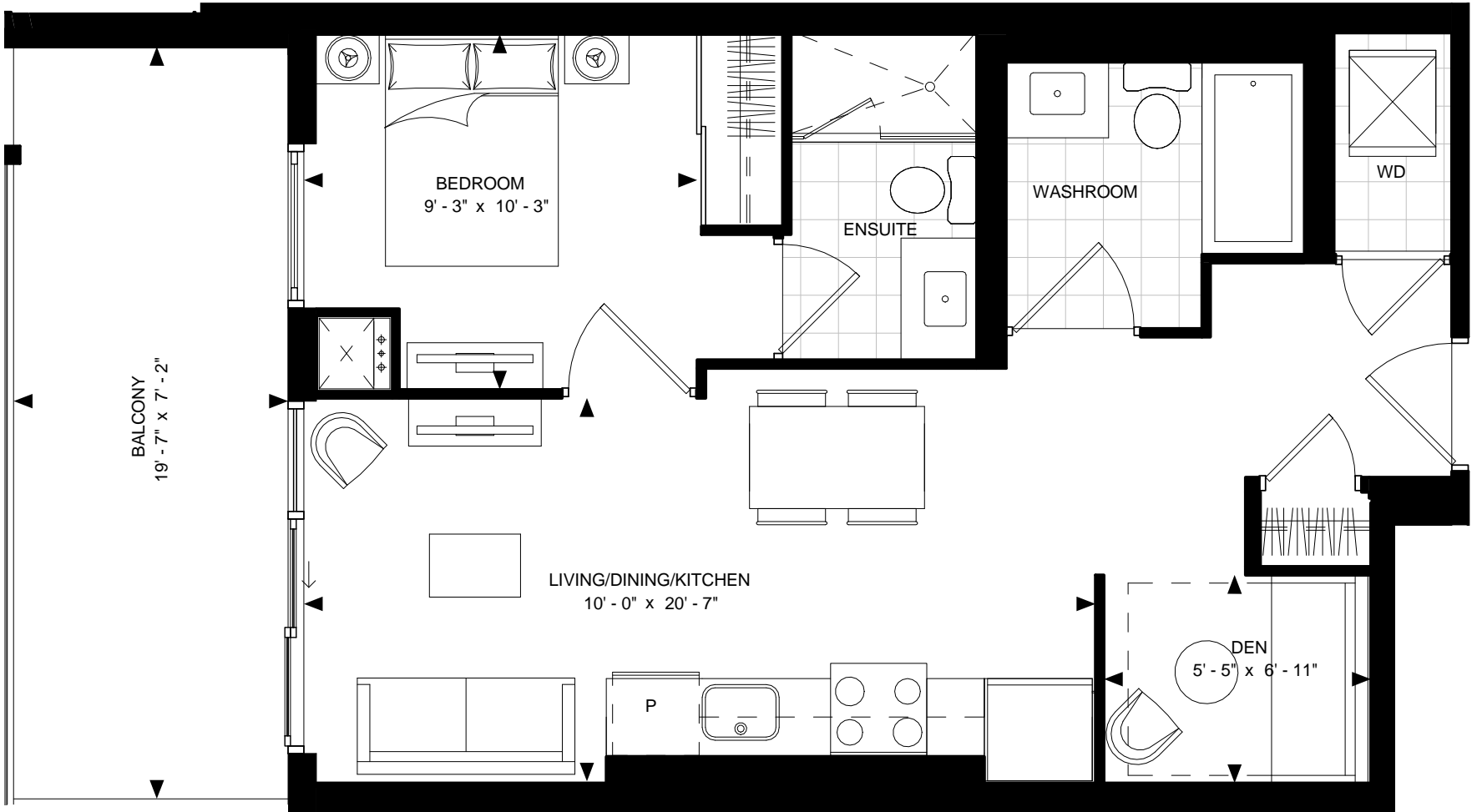

BALCONY AT SUITES 308, 311, 508-908, 511-911

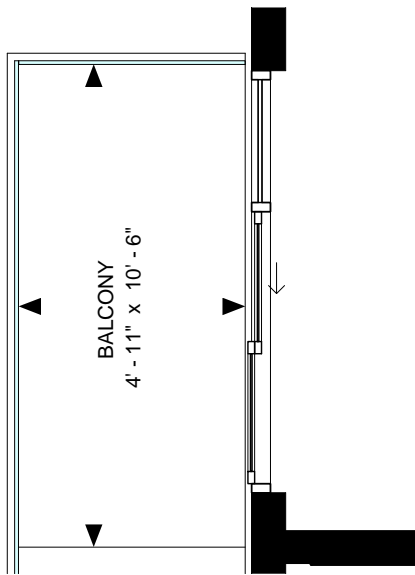

BALCONY AT SUITES 1111, 1211, 1511-3611, LPH11, PH11

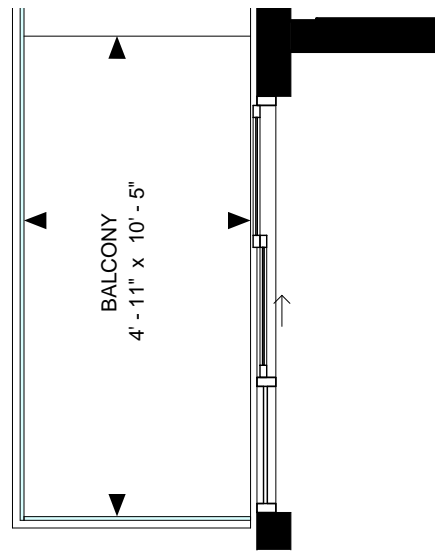

BALCONY AT SUITES 1108, 1208, 1508-3608, LPH08, PH08

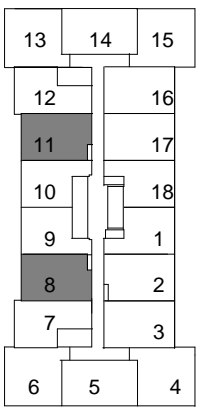

FLOOR 2-3, 5-9

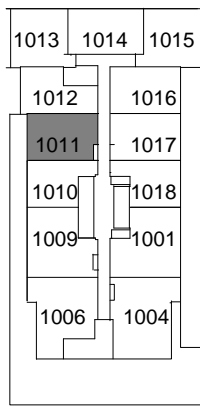

FLOOR 10

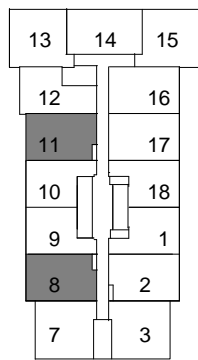

FLOOR 11-12, 15-36, LPH & PH

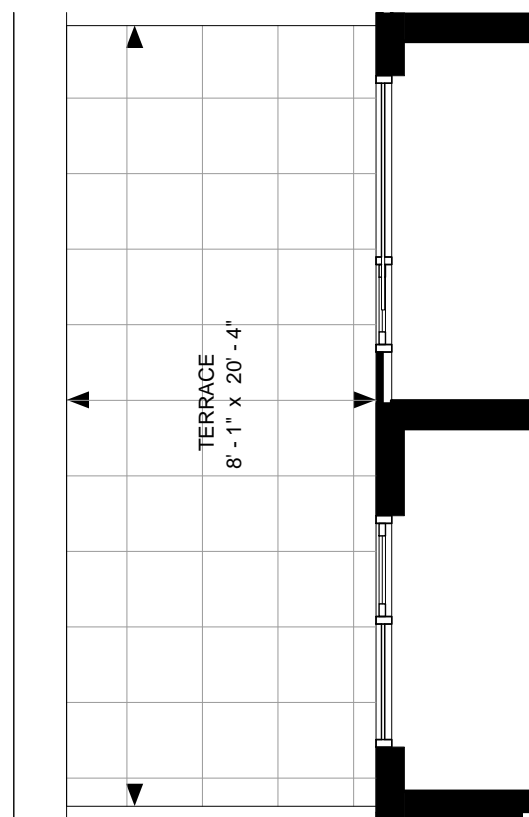

TERRACE AT SUITES 208, 211, 1011

SUITE 1D2-A (BF)
SUITE AREA: 611 sf



Disclaimer : Materials, specifications & floor plans are subject to change without notice. All renderings are artist's conceptions. All floor plans have approximate dimensions. Actual usable floor space may vary from the stated floor area. E.&O.E.

SUITE 1D2-B

THE MET

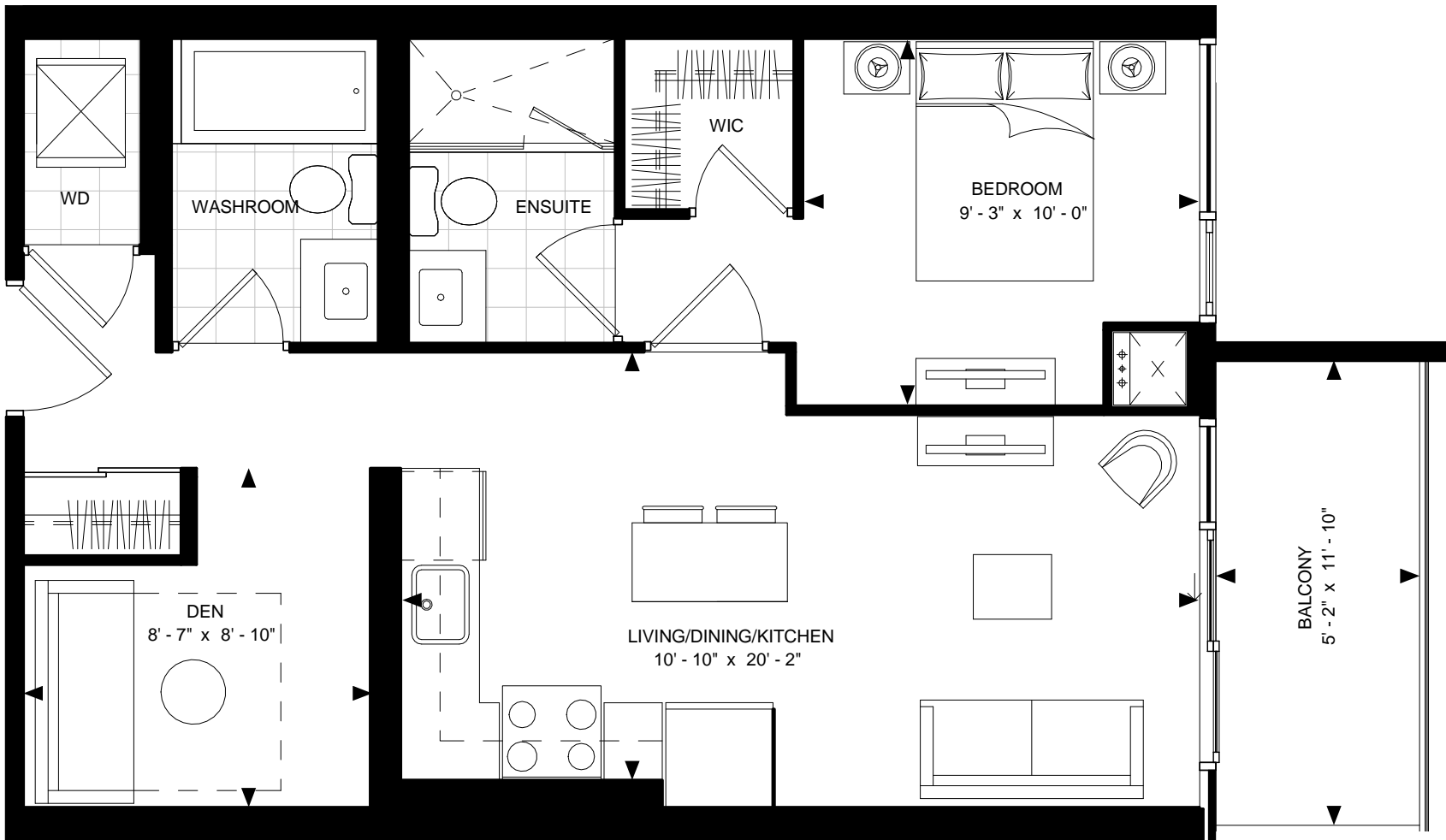

BALCONY AT SUITES 316, 516-1216,
1516-3616, 2717-3617, LPH16, PH16,
LPH17, PH17

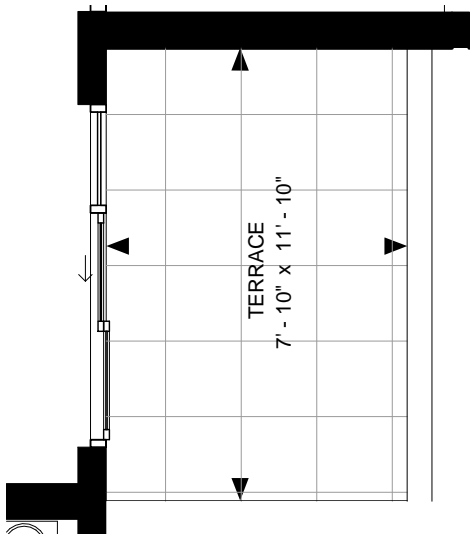

TERRACE AT SUITE 216

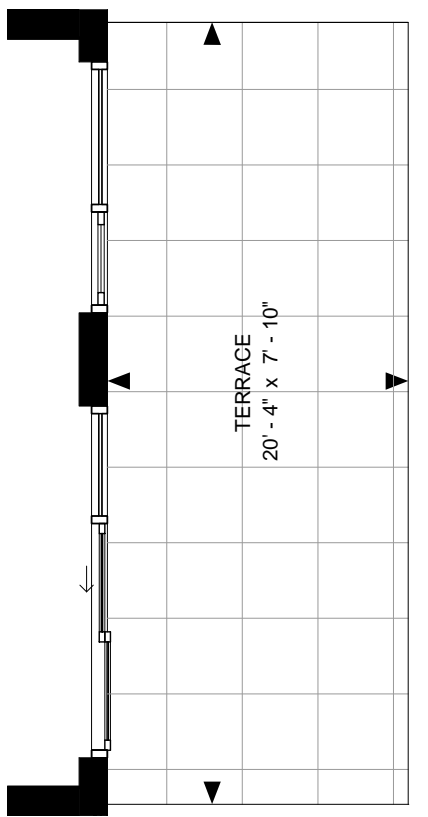

TERRACE AT SUITES 217

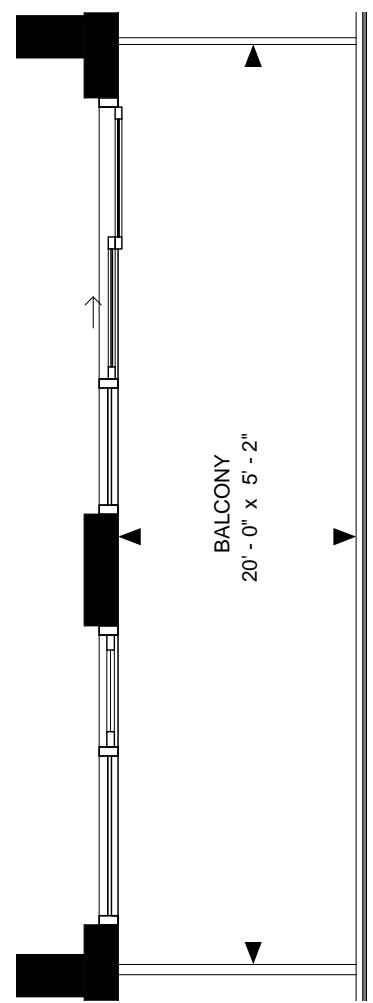

BALCONY AT SUITES 317, 517-1217,
1517-2617

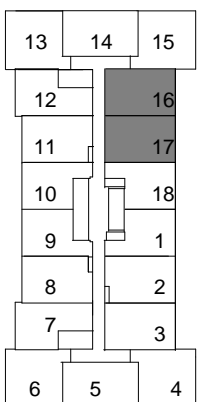

FLOOR 2-3, 5-9

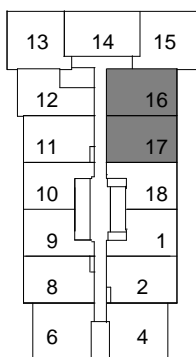

FLOOR 10-12, 15-36,
LPH & PH

SUITE 1D2-B
SUITE AREA: 624 sf



Disclaimer : Materials, specifications & floor plans are subject to change without notice. All renderings are artist's conceptions.
All floor plans have approximate dimensions. Actual usable floor space may vary from the stated floor area. E.&O.E.

NOT TO SCALE

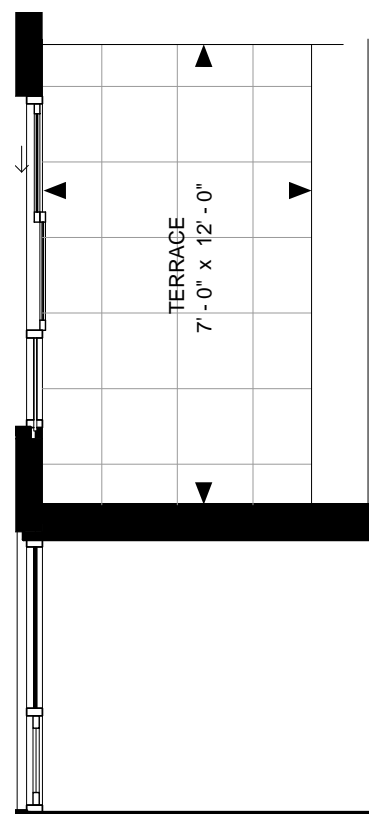
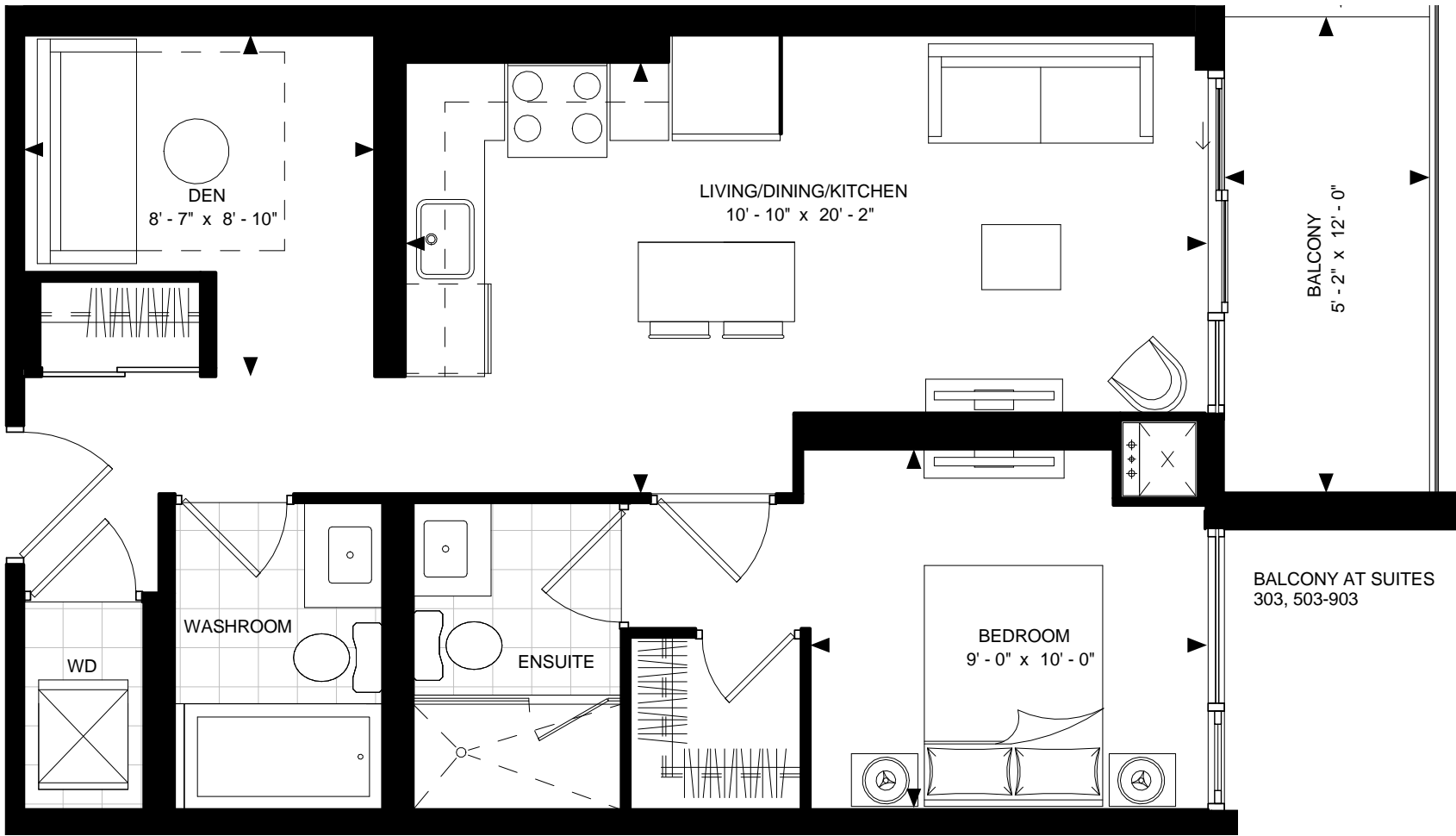

TERRACE AT SUITE 203

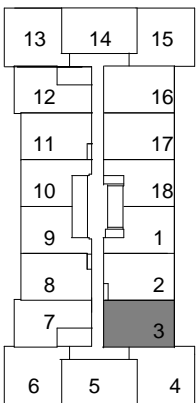

FLOOR 2-3, 5-9

SUITE 1D2-B1
SUITE AREA: 624 sf



Disclaimer : Materials, specifications & floor plans are subject to change without notice. All renderings are artist's conceptions. All floor plans have approximate dimensions. Actual usable floor space may vary from the stated floor area. E.&O.E.

SUITE 1D2-C

THE MET

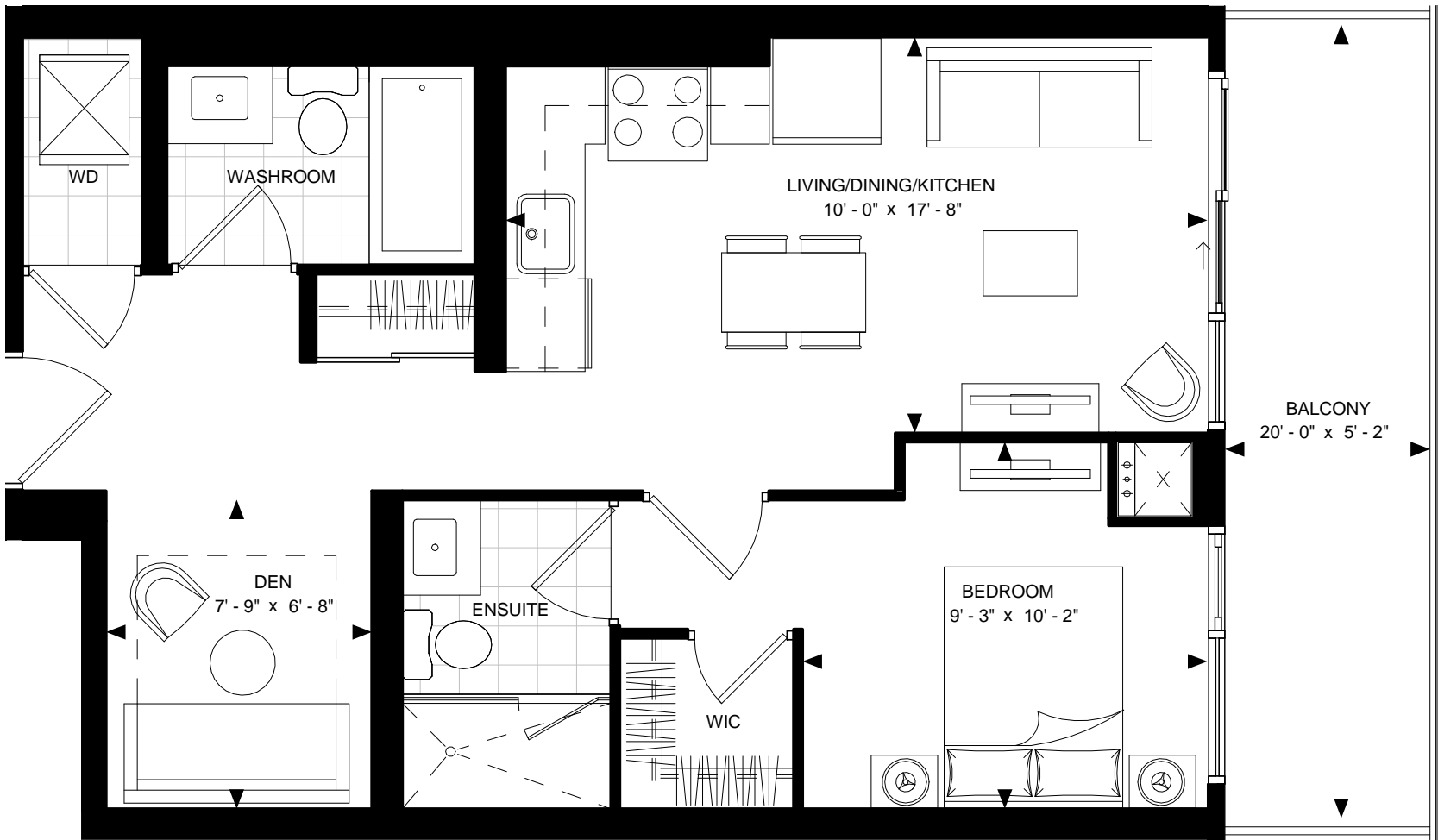

BALCONY AT SUITES 302, 502-902, 1102-1202, 1502-3602, LPH02, PH02

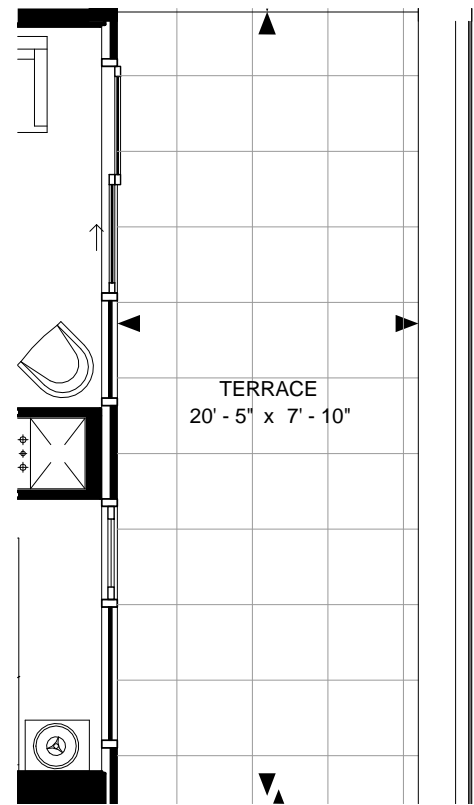

TERRACE AT SUITE 202

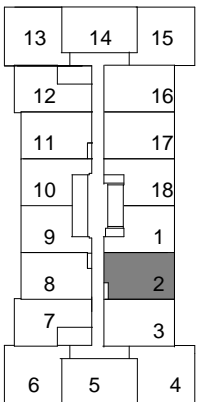

FLOOR 2-3, 5-9

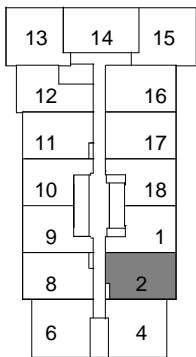

FLOOR 11-12, 15-36,
LPH & PH

SUITE 1D2-C
SUITE AREA: 611 sf

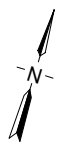

Disclaimer : Materials, specifications & floor plans are subject to change without notice. All renderings are artist's conceptions. All floor plans have approximate dimensions. Actual usable floor space may vary from the stated floor area. E.&O.E.

NOT TO SCALE

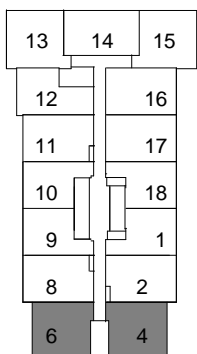
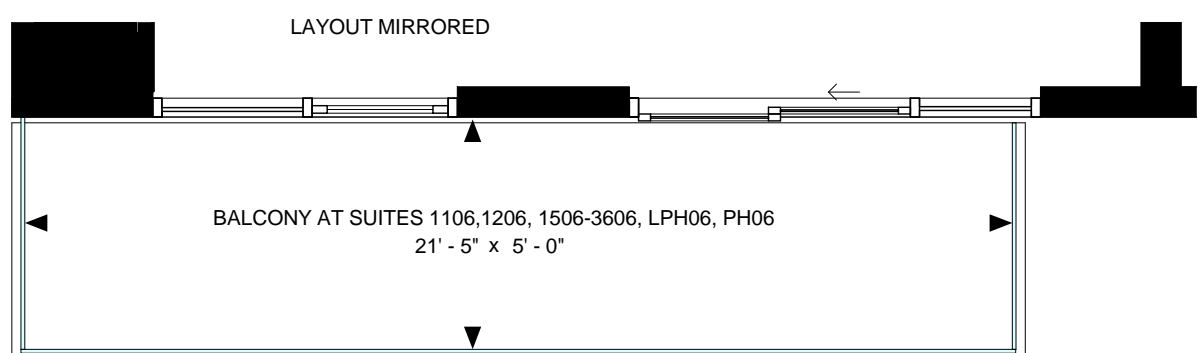
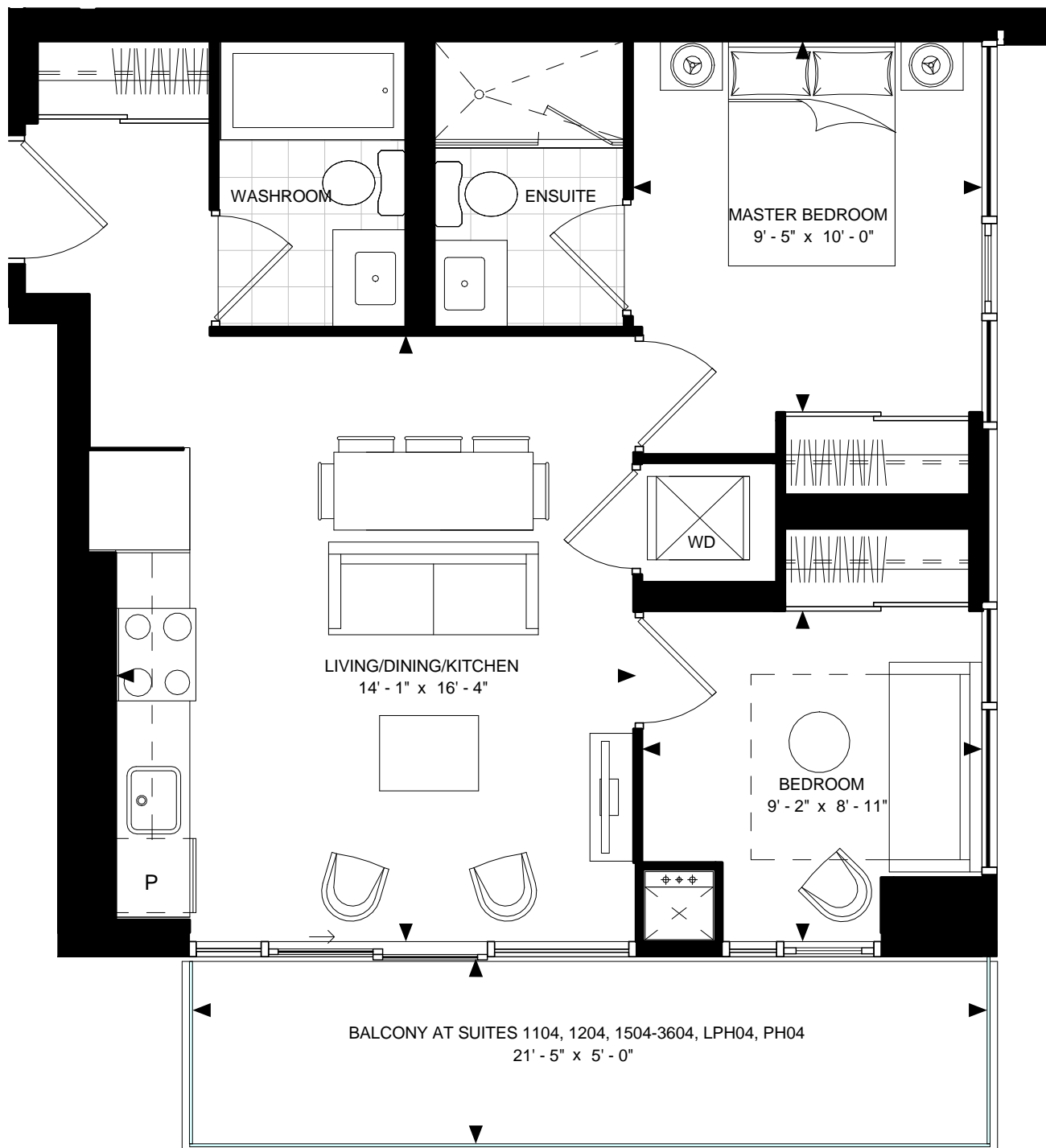

FLOOR 11, 12, 15-36,
LPH & PH

SUITE 2-A1
SUITE AREA: 649 sf



Disclaimer : Materials, specifications & floor plans are subject to change without notice. All renderings are artist's conceptions.
All floor plans have approximate dimensions. Actual usable floor space may vary from the stated floor area. E.&O.E.

NOT TO SCALE

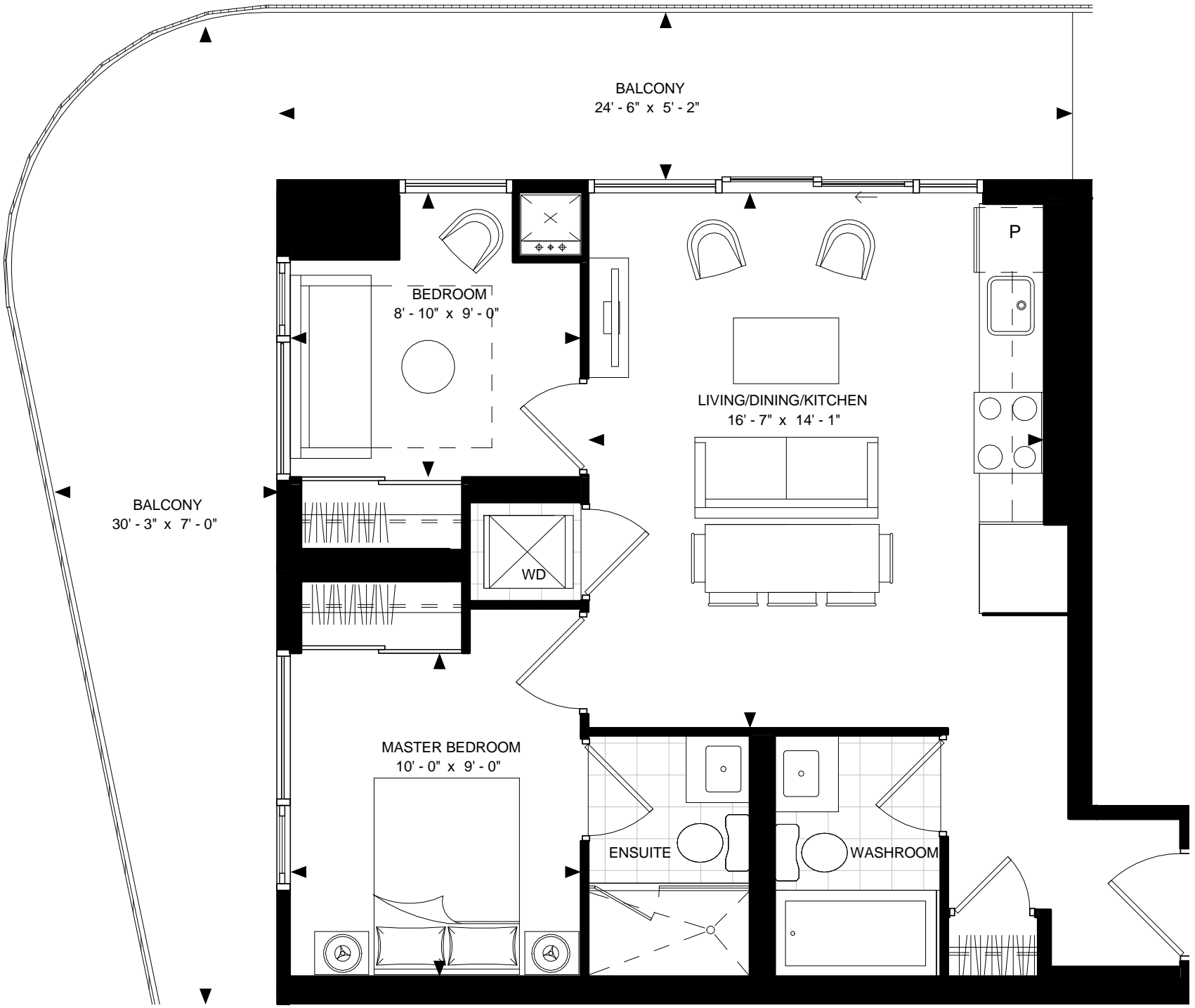

BALCONY AT SUITES 213, 313, 513-1213, 1513-3613, LPH13, PH13

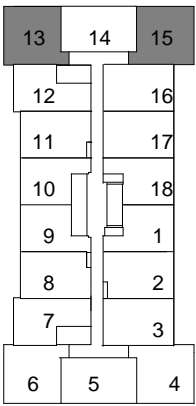

FLOOR 2-3, 5-9

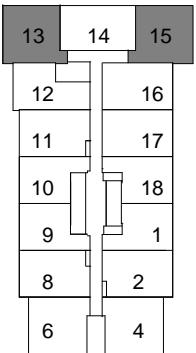

FLOOR 10-12, 15-36, LPH & PH

SUITE 2-A2
SUITE AREA: 649 sf

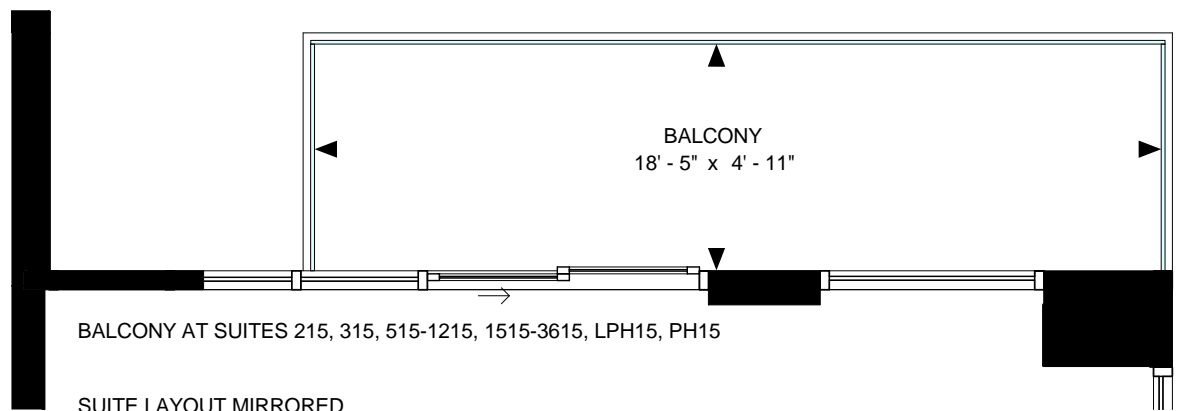

Disclaimer : Materials, specifications & floor plans are subject to change without notice. All renderings are artist's conceptions. All floor plans have approximate dimensions. Actual usable floor space may vary from the stated floor area. E.&O.E.

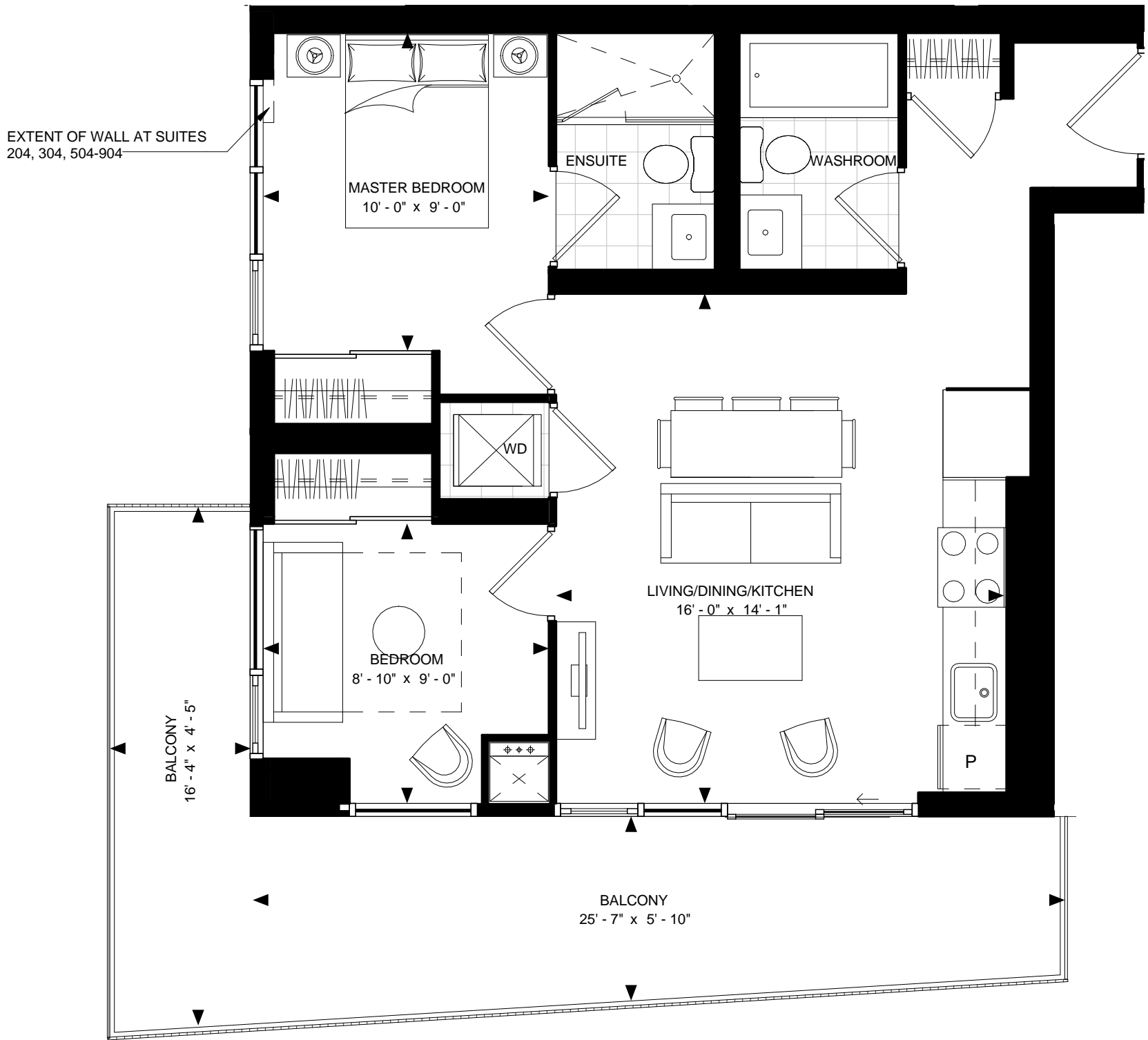

BALCONY AT SUITES 206, 306, 506-906

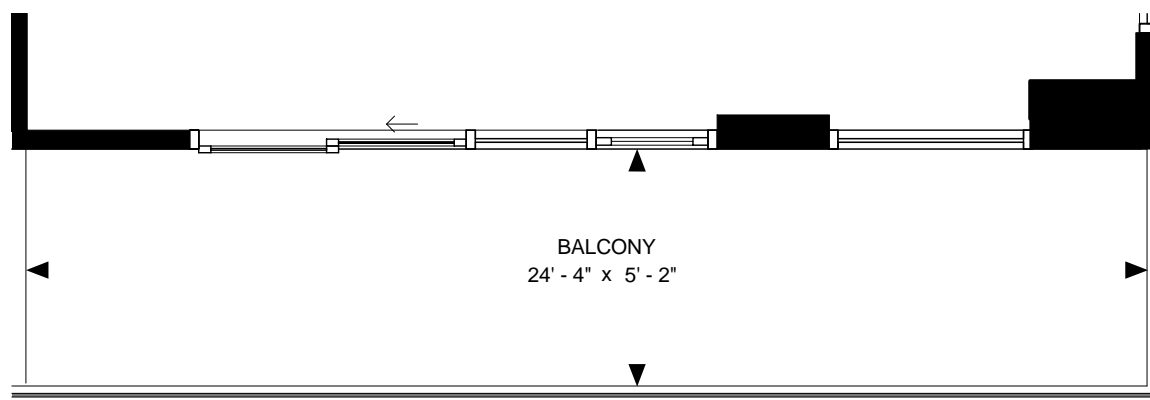

BALCONY AT SUITES 204, 304, 504-904

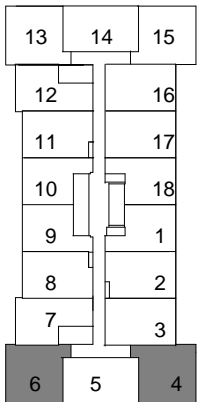

FLOOR 2-3, 5-9

SUITE 2-A3
SUITE AREA: 649 sf



Disclaimer : Materials, specifications & floor plans are subject to change without notice. All renderings are artist's conceptions. All floor plans have approximate dimensions. Actual usable floor space may vary from the stated floor area. E.&O.E.

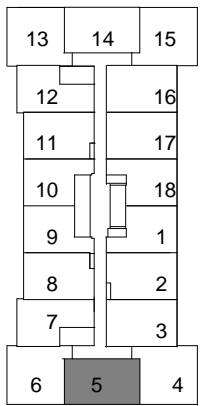
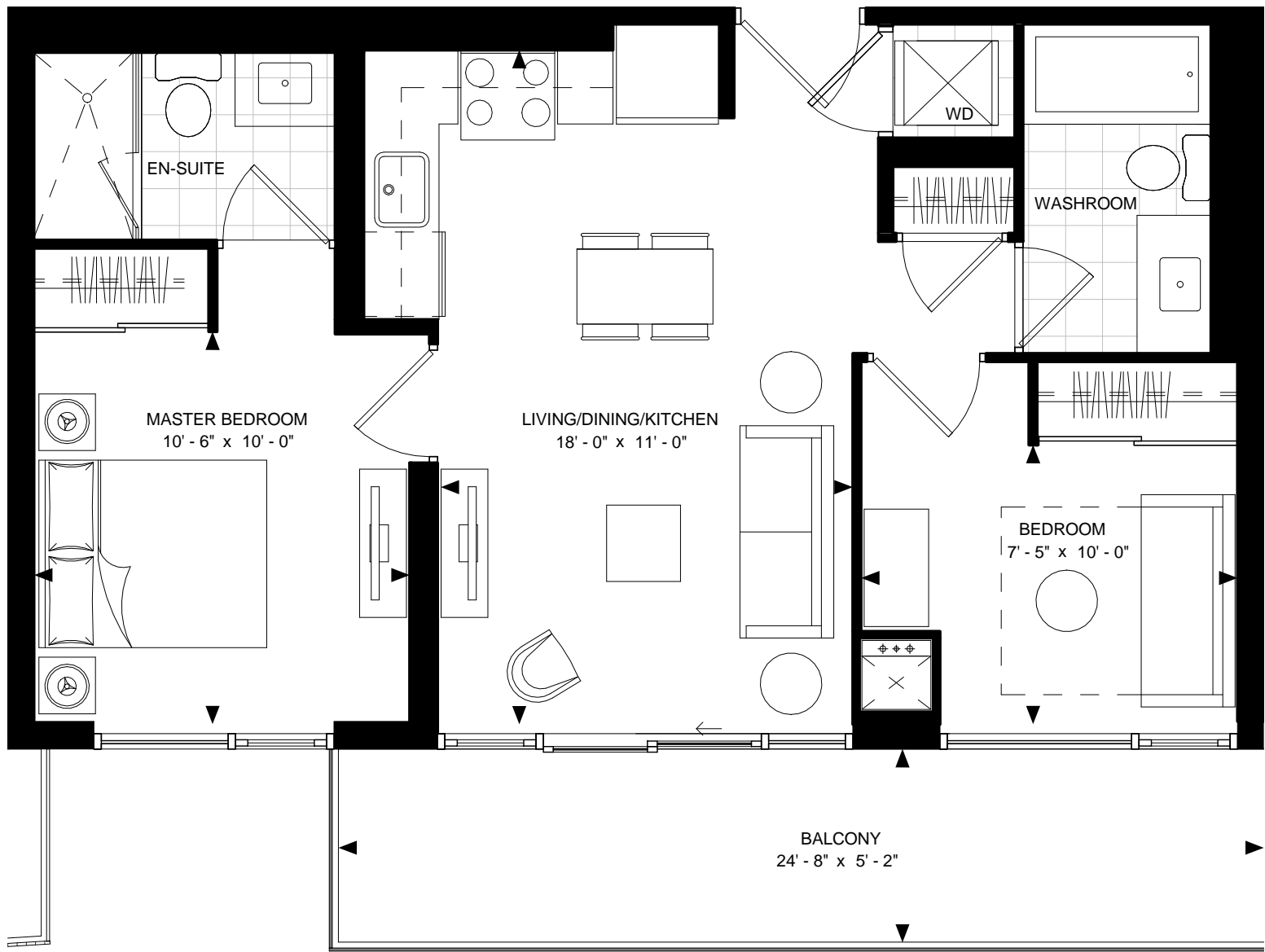

FLOOR 2-3, 5-9

SUITE 2-B
SUITE AREA: 649 sf



Disclaimer : Materials, specifications & floor plans are subject to change without notice. All renderings are artist's conceptions. All floor plans have approximate dimensions. Actual usable floor space may vary from the stated floor area. E.&O.E.

NOT TO SCALE

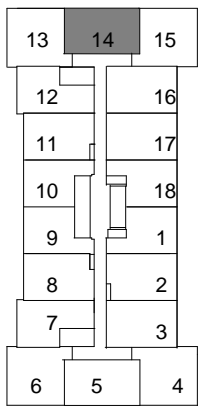
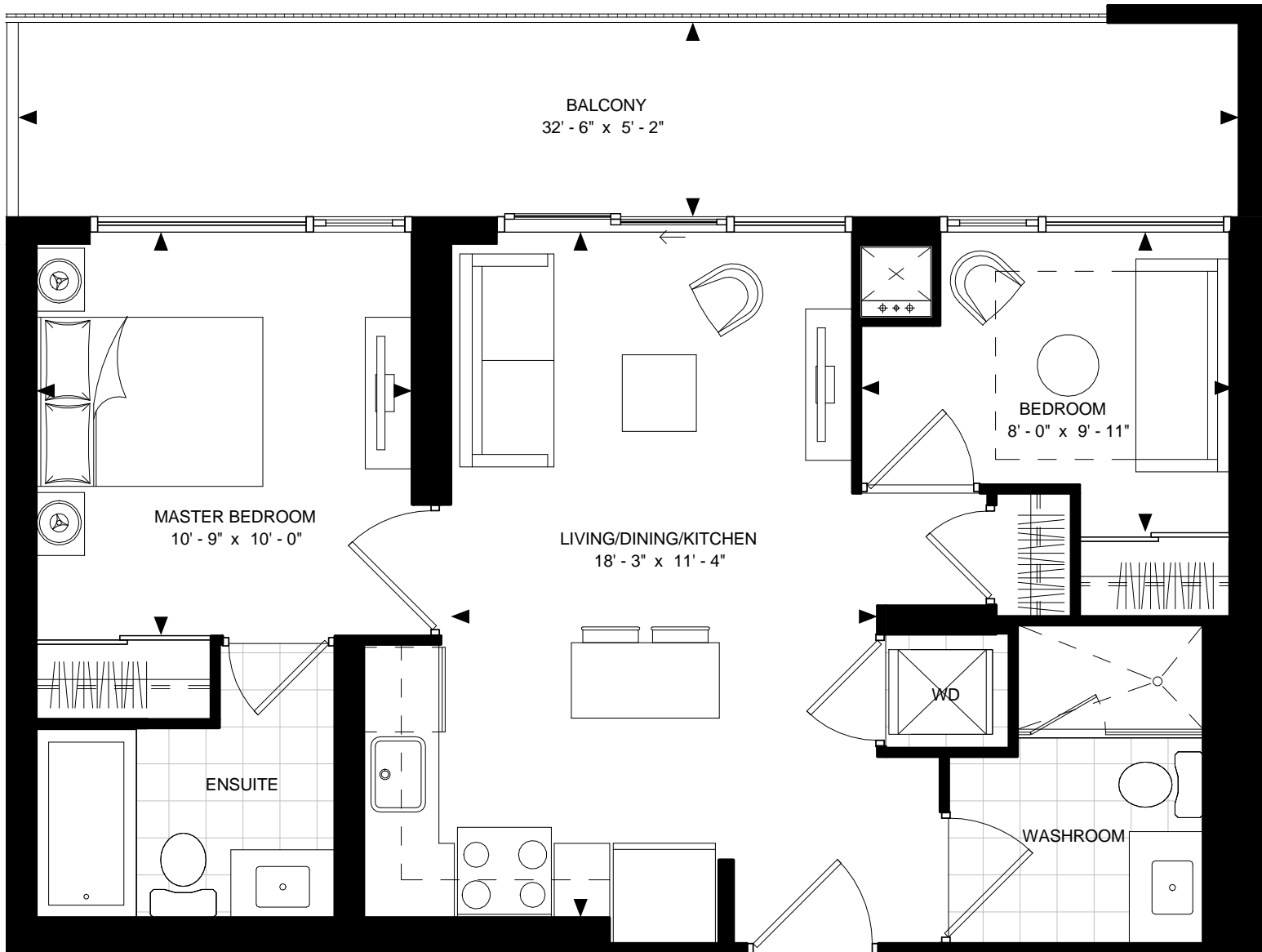

FLOOR 2-3, 5-9

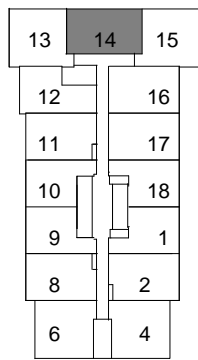

FLOOR 10-12, 15-36, LPH & PH

SUITE 2-C
SUITE AREA: 649 sf

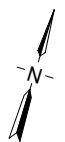

Disclaimer : Materials, specifications & floor plans are subject to change without notice. All renderings are artist's conceptions. All floor plans have approximate dimensions. Actual usable floor space may vary from the stated floor area. E.&O.E.

SUITE TH-A1

THE MET

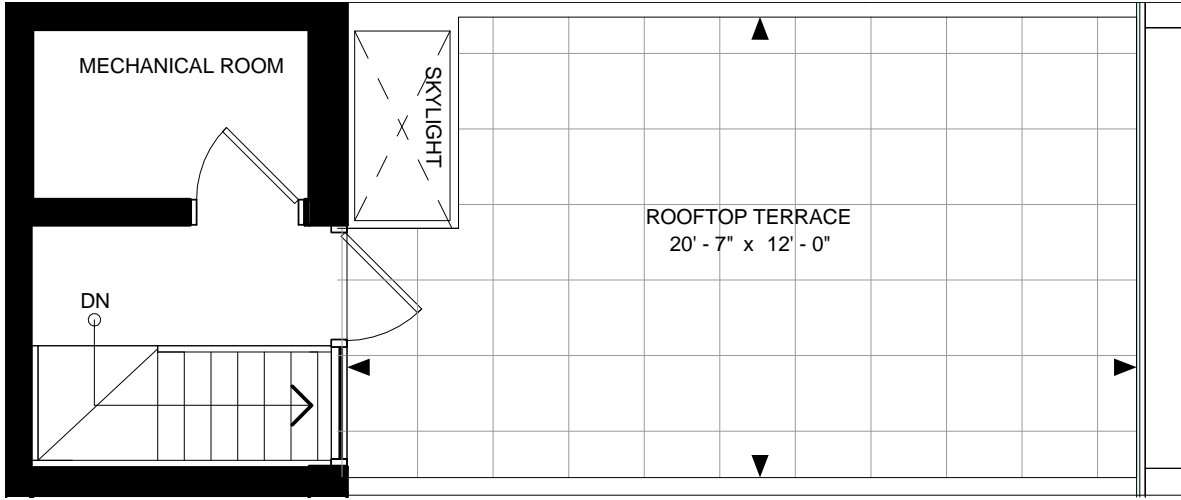

ROOF

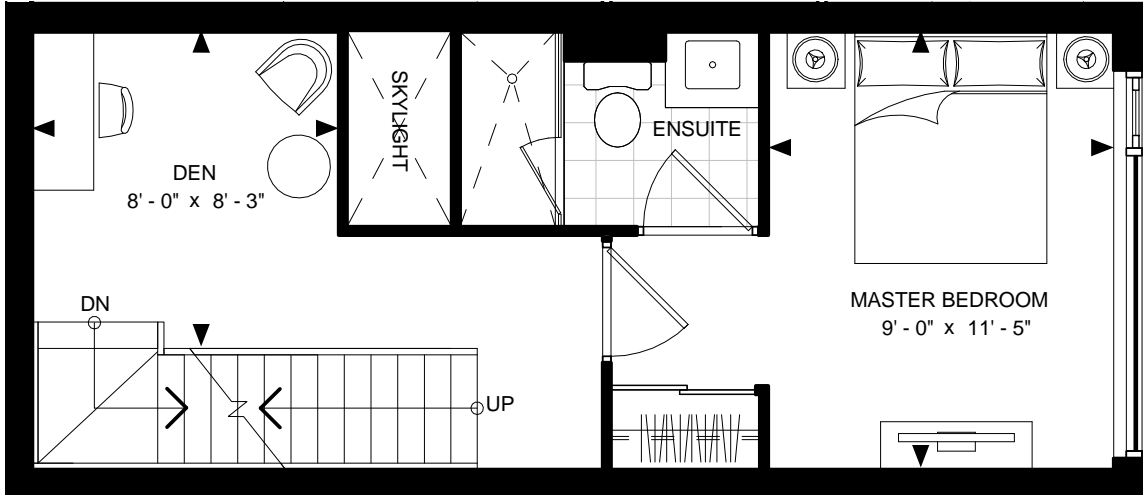

LEVEL 3

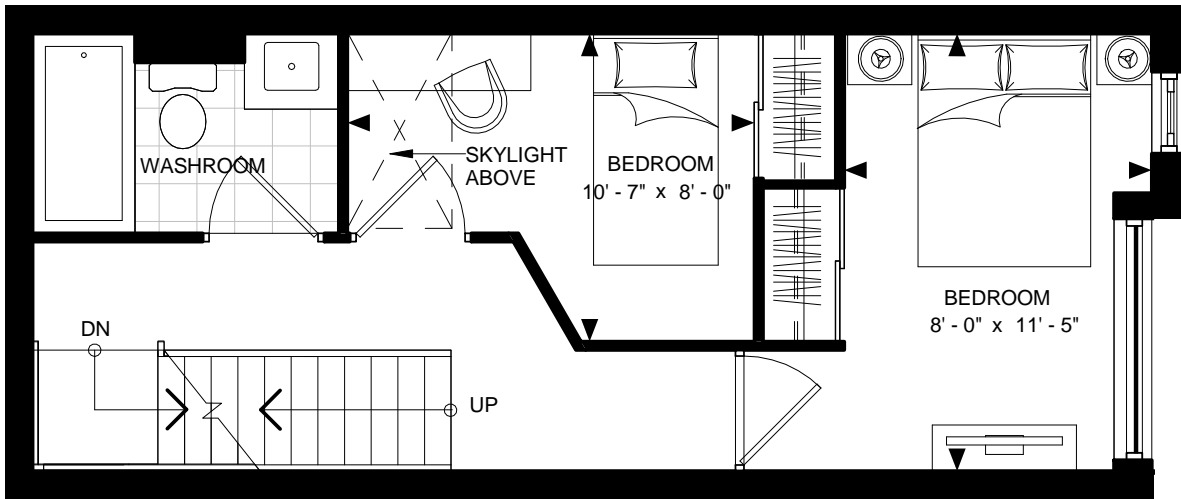

LEVEL 2 AND OPTIONAL LEVEL 3

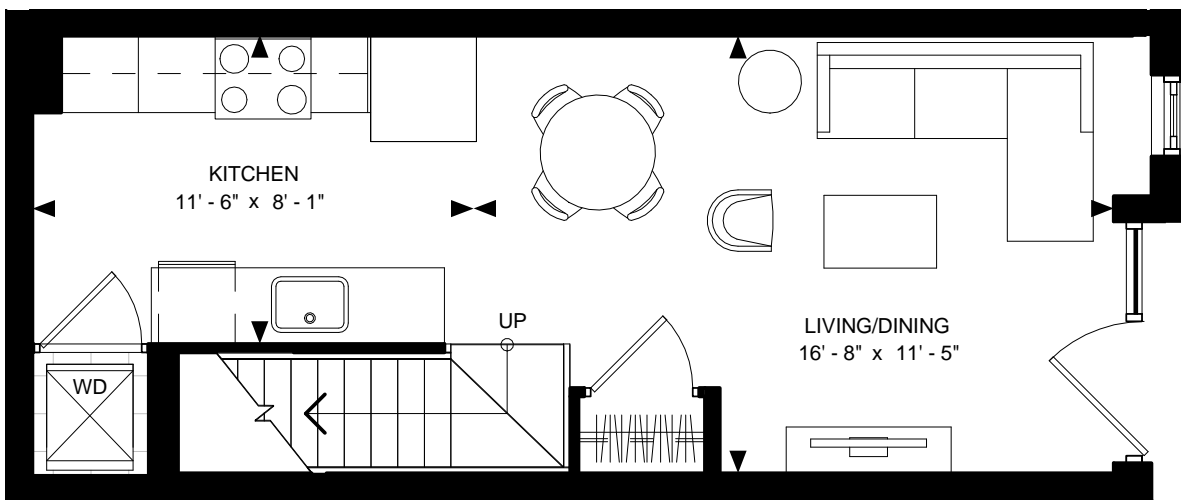

GROUND FLOOR

SUITE TH A1
SUITE AREA: 1,200 sf

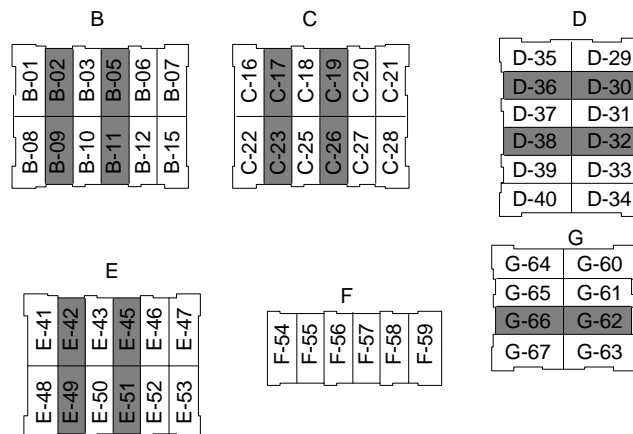

Disclaimer : Materials, specifications & floor plans are subject to change without notice. All renderings are artist's conceptions. All floor plans have approximate dimensions. Actual usable floor space may vary from the stated floor area. E.&O.E.

NOT TO SCALE

SUITE TH-A2

THE MET

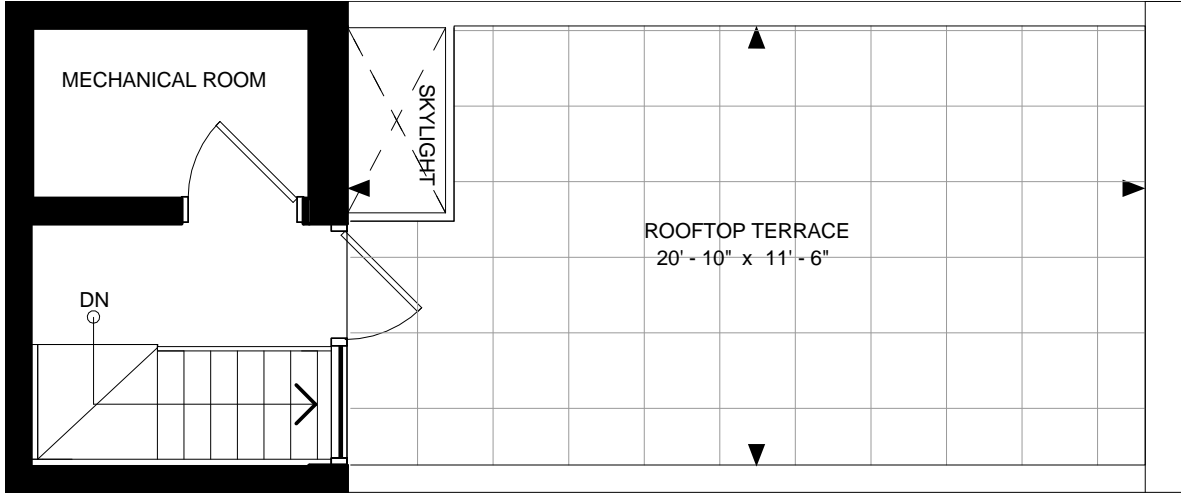

ROOF

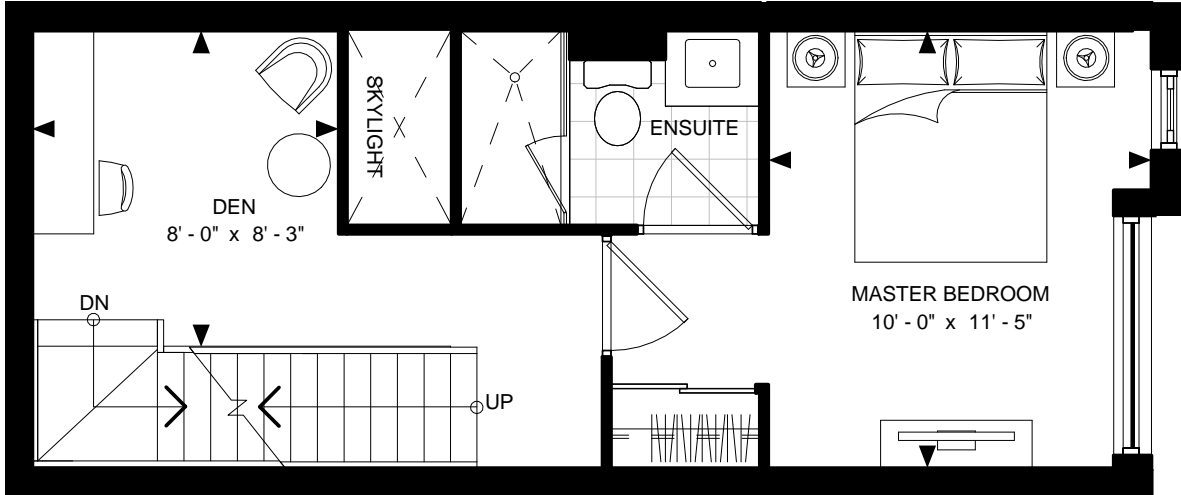

LEVEL 3

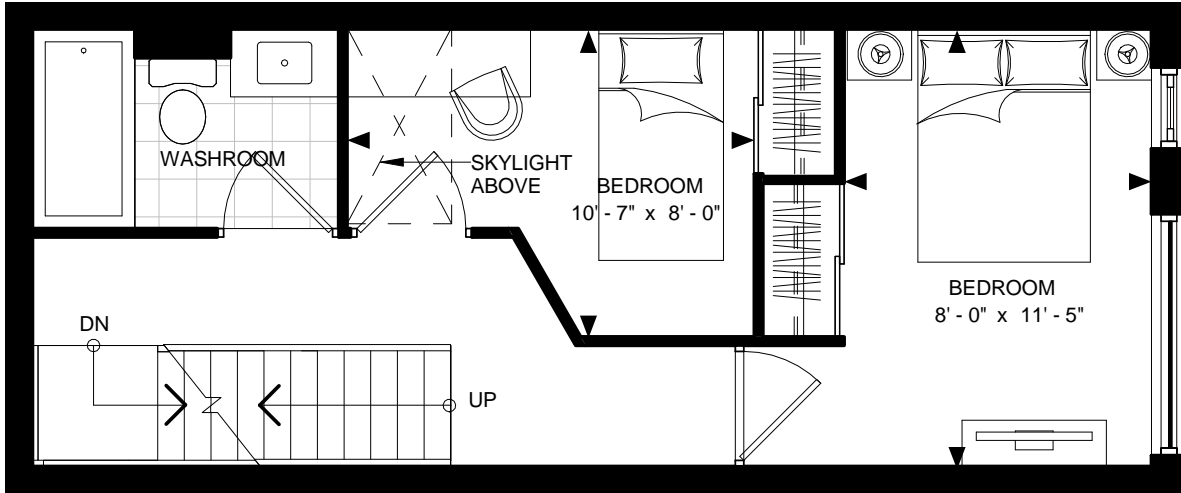

LEVEL 2 AND OPTIONAL LEVEL 3

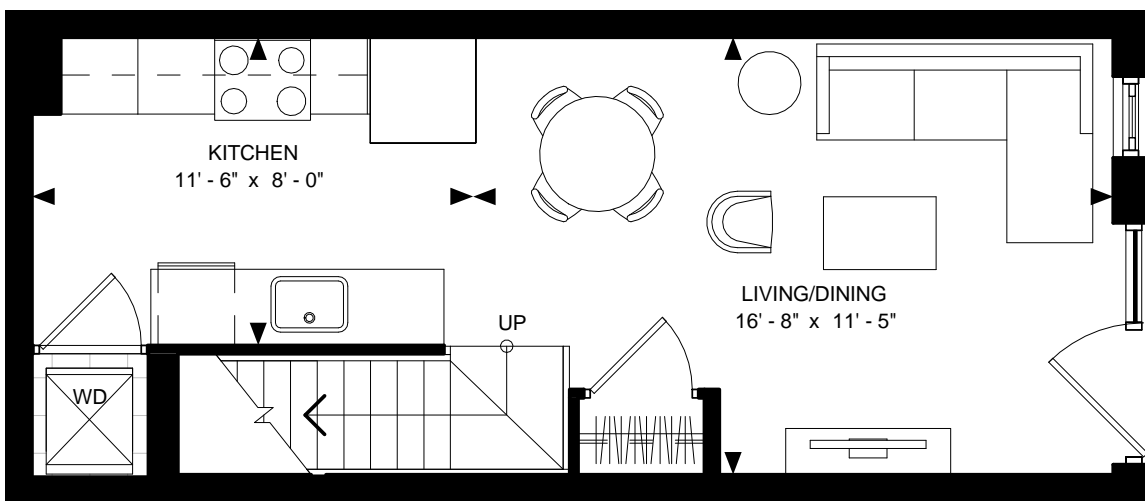

GROUND FLOOR

SUITE TH A2
SUITE AREA: 1,205 sf

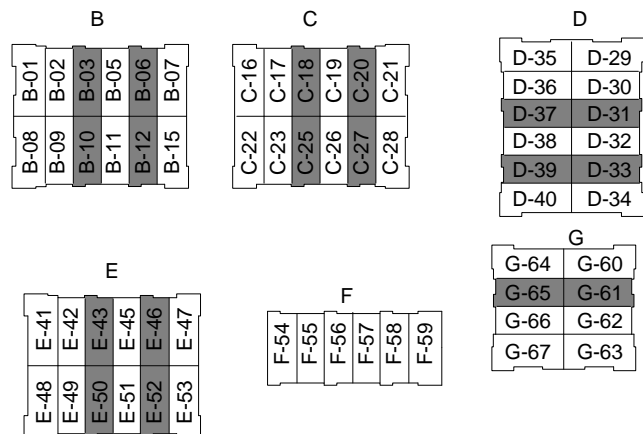

Disclaimer : Materials, specifications & floor plans are subject to change without notice. All renderings are artist's conceptions. All floor plans have approximate dimensions. Actual usable floor space may vary from the stated floor area. E.&O.E.

NOT TO SCALE

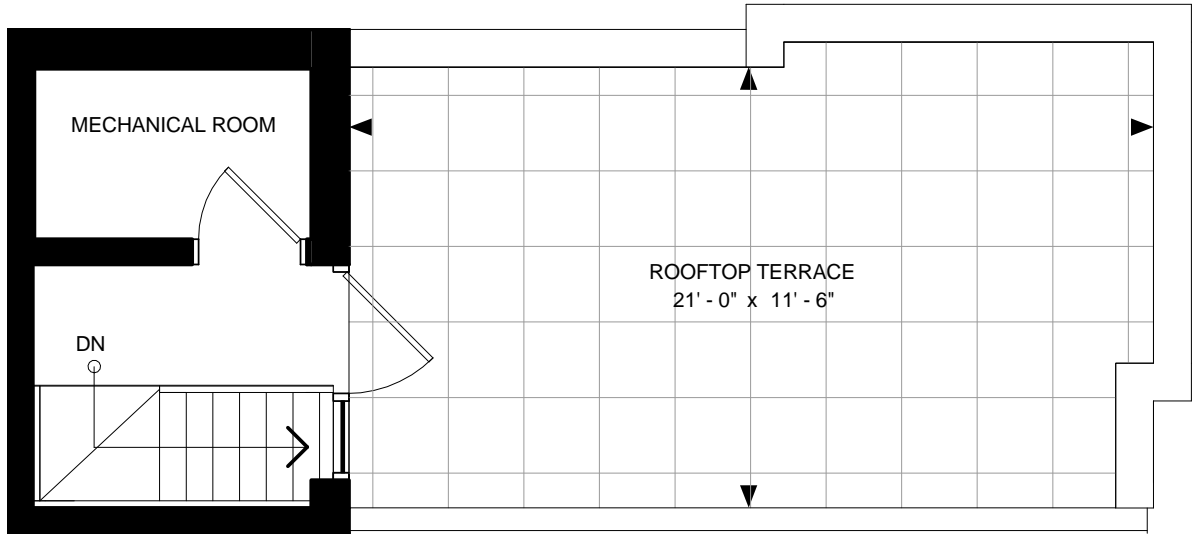

ROOF

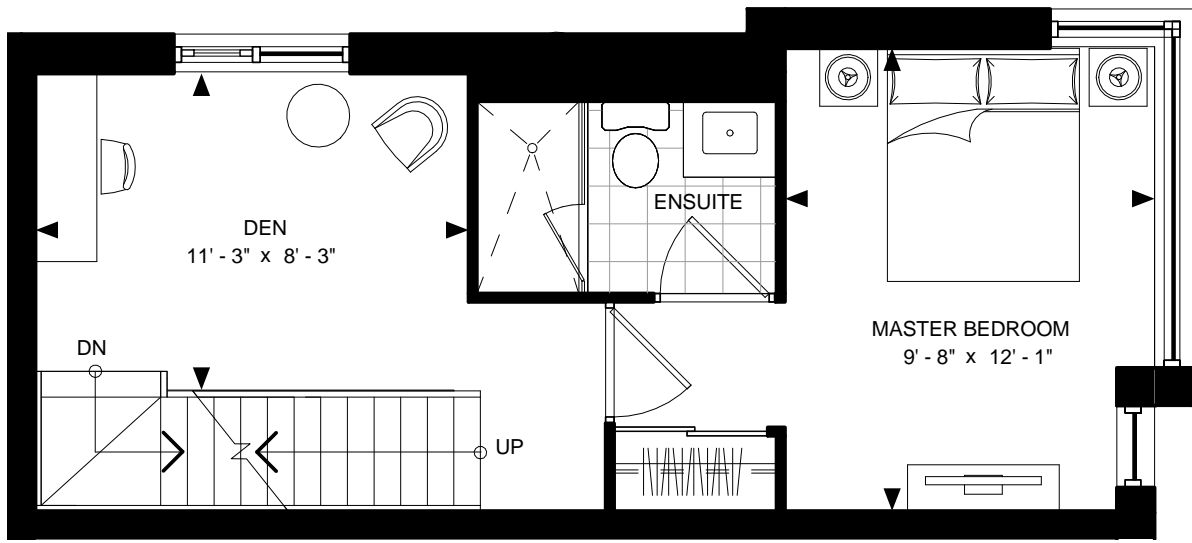

LEVEL 3

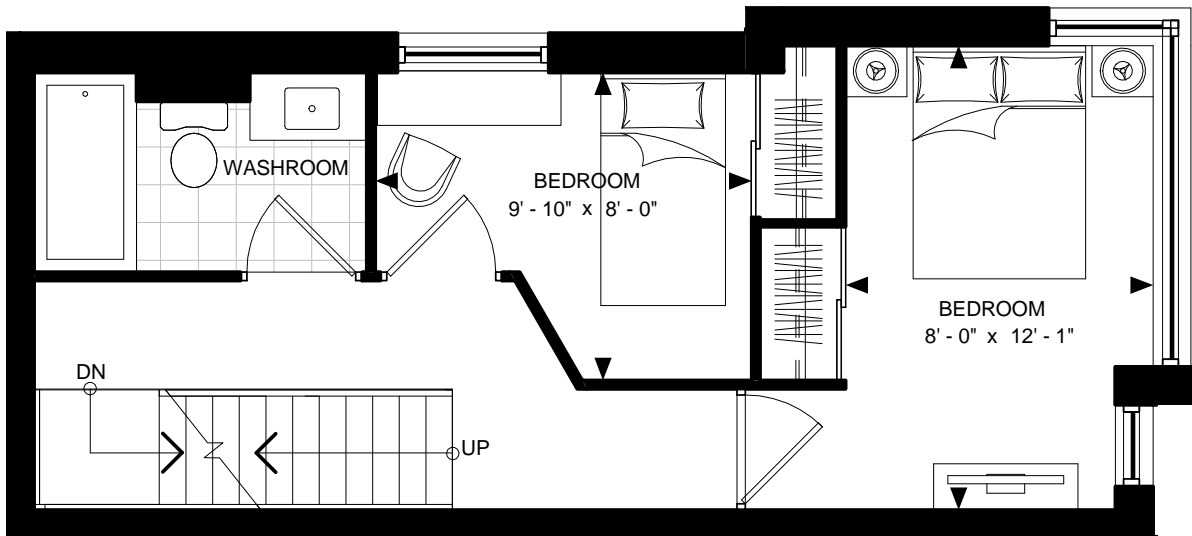

LEVEL 2 AND OPTIONAL LEVEL 3

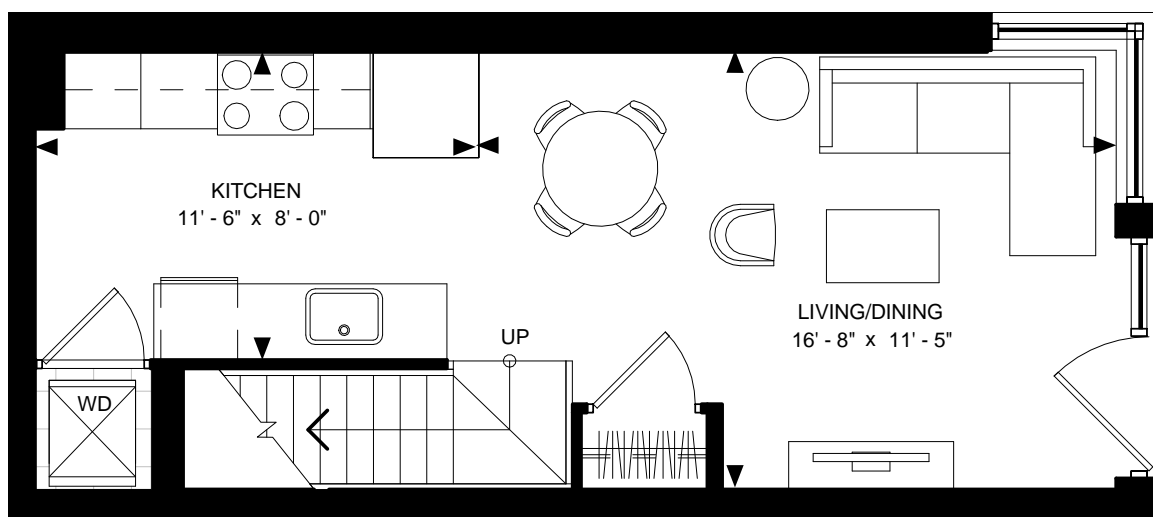

GROUND FLOOR

SUITE TH C1
SUITE AREA: 1,283 sf

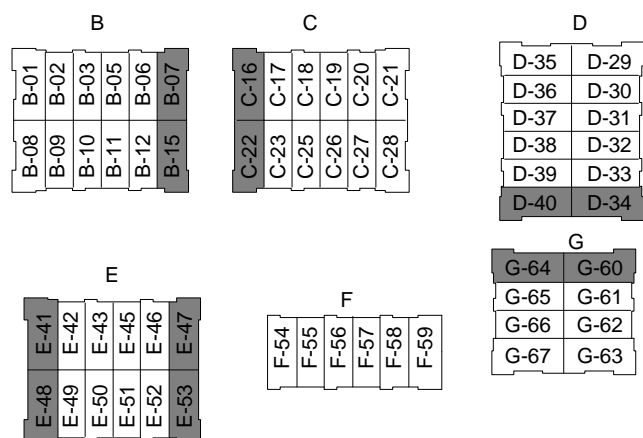

Disclaimer : Materials, specifications & floor plans are subject to change without notice. All renderings are artist's conceptions. All floor plans have approximate dimensions. Actual usable floor space may vary from the stated floor area. E.&O.E.

SUITE TH-C2

THE MET

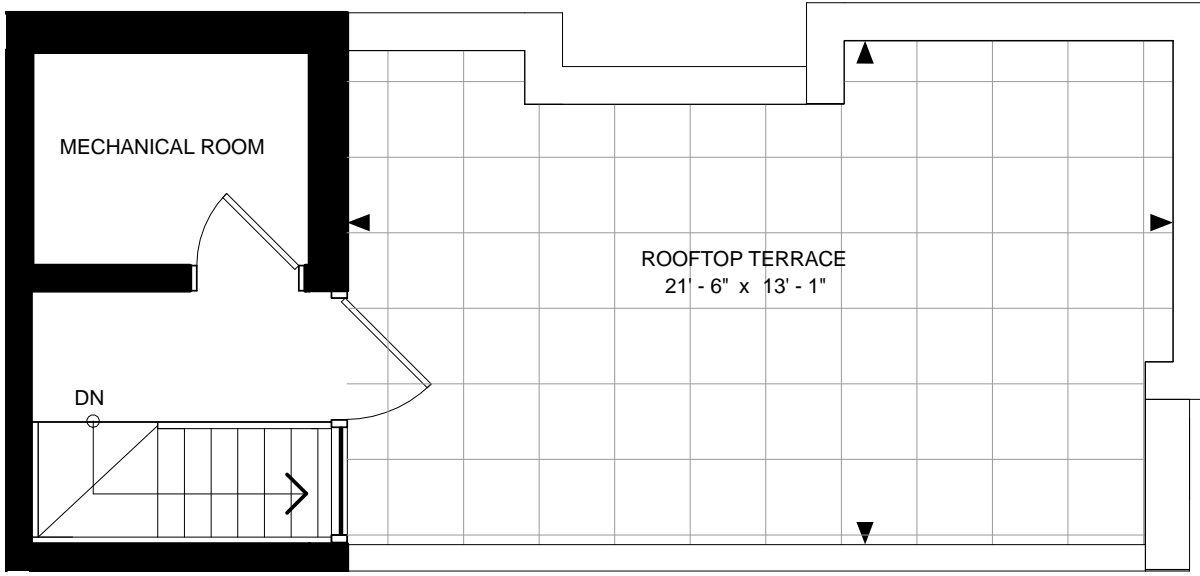

ROOF

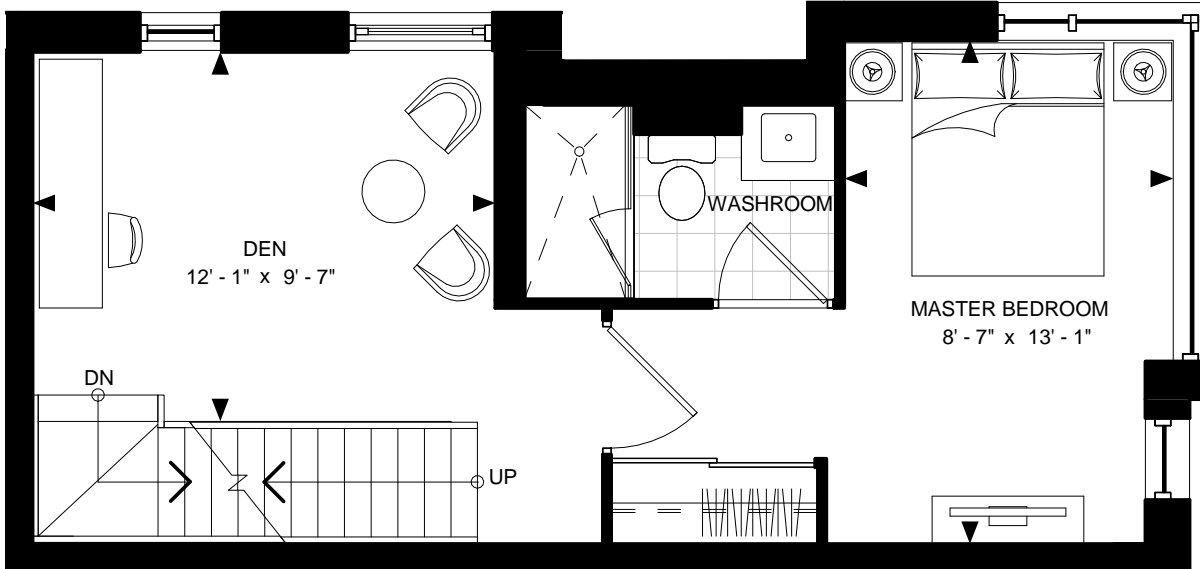

LEVEL 3

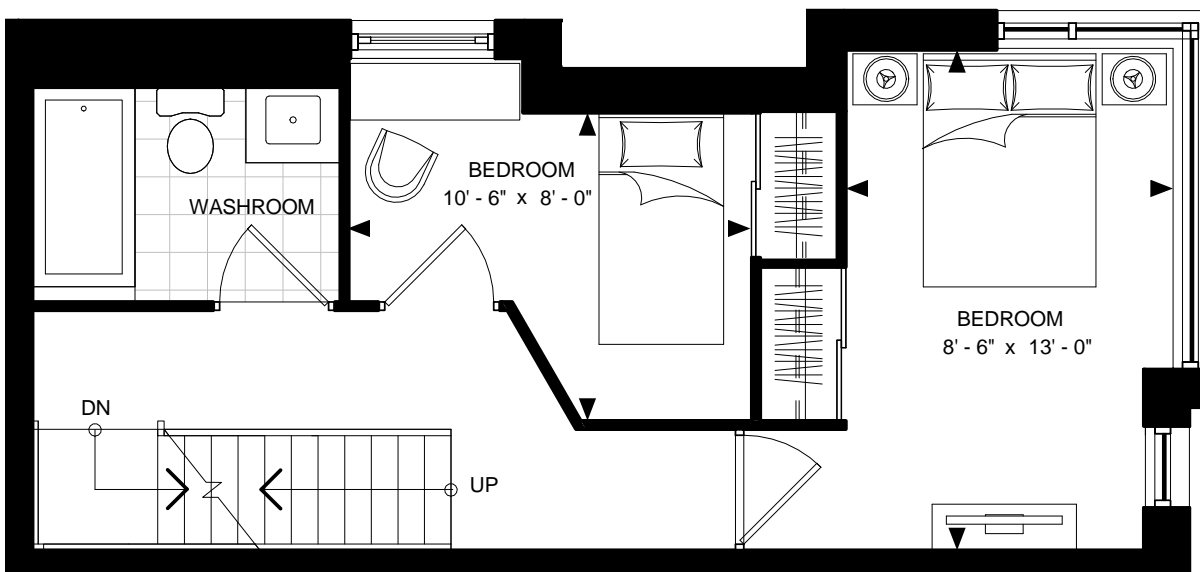

LEVEL 2 AND OPTIONAL LEVEL 3

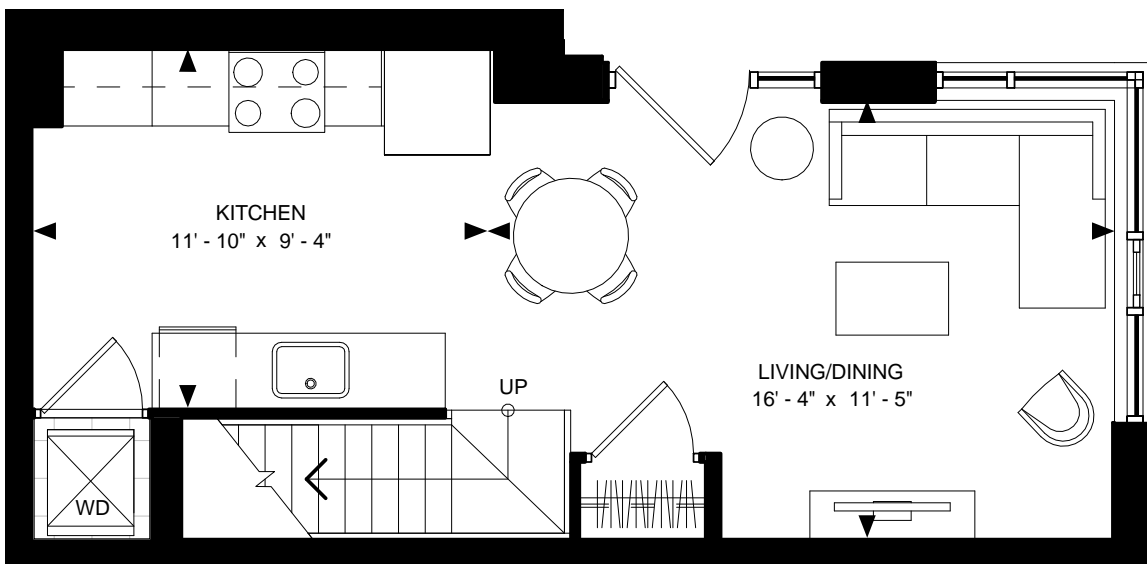

GROUND FLOOR

SUITE TH C2
SUITE AREA: 1,327 sf

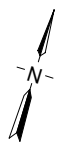
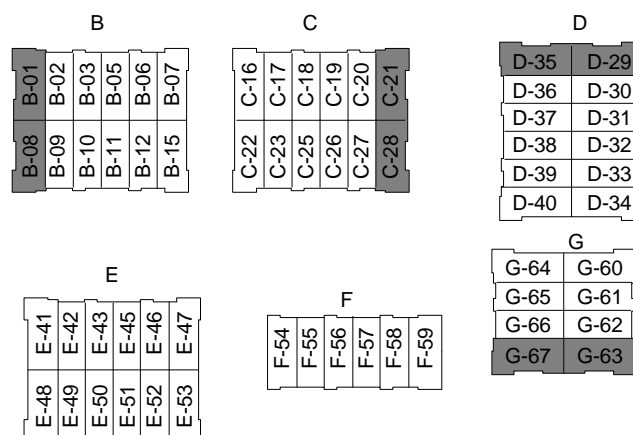

Disclaimer : Materials, specifications & floor plans are subject to change without notice. All renderings are artist's conceptions. All floor plans have approximate dimensions. Actual usable floor space may vary from the stated floor area. E.&O.E.

NOT TO SCALE